

EasyLogic™ PM2200 series

User Manual

NHA2778902-05
02/2020



Legal Information

The Schneider Electric brand and any trademarks of Schneider Electric SE and its subsidiaries referred to in this guide are the property of Schneider Electric SE or its subsidiaries. All other brands may be trademarks of their respective owners.

This guide and its content are protected under applicable copyright laws and furnished for informational use only. No part of this guide may be reproduced or transmitted in any form or by any means (electronic, mechanical, photocopying, recording, or otherwise), for any purpose, without the prior written permission of Schneider Electric.

Schneider Electric does not grant any right or license for commercial use of the guide or its content, except for a non-exclusive and personal license to consult it on an "as is" basis. Schneider Electric products and equipment should be installed, operated, serviced, and maintained only by qualified personnel.

As standards, specifications, and designs change from time to time, information contained in this guide may be subject to change without notice.

To the extent permitted by applicable law, no responsibility or liability is assumed by Schneider Electric and its subsidiaries for any errors or omissions in the informational content of this material or consequences arising out of or resulting from the use of the information contained herein.

Safety information

Important information

Read these instructions carefully and look at the equipment to become familiar with the device before trying to install, operate, service, or maintain it. The following special messages may appear throughout this manual or on the equipment to warn of potential hazards or to call attention to information that clarifies or simplifies a procedure.



The addition of either symbol to a “Danger” or “Warning” safety label indicates that an electrical hazard exists which will result in personal injury if the instructions are not followed.



This is the safety alert symbol. It is used to alert you to potential personal injury hazards. Obey all safety messages that accompany this symbol to avoid possible injury or death.

DANGER

DANGER indicates a hazardous situation which, if not avoided, **will result in death or serious injury**.

Failure to follow these instructions will result in death or serious injury.

WARNING

WARNING indicates a hazardous situation which, if not avoided, **could result in death or serious injury**.

CAUTION

CAUTION indicates a hazardous situation which, if not avoided, **could result in minor or moderate injury**.

NOTICE

NOTICE is used to address practices not related to physical injury.

Please note

Electrical equipment should be installed, operated, serviced and maintained only by qualified personnel. No responsibility is assumed by Schneider Electric for any consequences arising out of the use of this material. A qualified person is one who has skills and knowledge related to the construction, installation, and operation of electrical equipment and has received safety training to recognize and avoid the hazards involved.

Notices

FCC

This equipment has been tested and found to comply with the limits for a Class A digital device, pursuant to Part 15 of the FCC rules. These limits are designed to provide reasonable protection against harmful interference when the equipment is operated in a commercial environment. This equipment generates, uses, and can radiate radio frequency energy and, if not installed and used in accordance with the instruction manual, may cause harmful interference to radio communications. Operation of this equipment in a residential area is likely to cause harmful interference in which case the user will be required to correct the interference at his own expense.

The user is cautioned that any changes or modifications not expressly approved by Schneider Electric could void the user's authority to operate the equipment.

This digital apparatus complies with CAN ICES-3 (A) /NMB-3(A).

Table of Contents

| | |
|---|----|
| Safety precautions | 9 |
| Introduction | 10 |
| Meter overview | 10 |
| Meter Features | 10 |
| Feature summary | 10 |
| Measured parameters | 12 |
| Energy | 12 |
| Non Reset energy | 12 |
| Demand | 12 |
| Instantaneous | 12 |
| Power quality | 13 |
| Data recording | 13 |
| Input/output | 13 |
| Other measurements | 13 |
| Data display and analysis tools | 13 |
| Power Monitoring Expert | 13 |
| Power SCADA Operation | 14 |
| Meter configuration | 14 |
| Hardware references | 15 |
| PM2200 meter models and accessories | 15 |
| Supplemental information | 15 |
| Meter wiring considerations | 16 |
| Direct connect voltage limits | 16 |
| Balanced system considerations | 17 |
| RS-485 wiring | 18 |
| Pulse output | 18 |
| Meter display | 20 |
| Display overview | 20 |
| LED indicators | 20 |
| Alarm / energy pulsing LED | 20 |
| Heartbeat / serial communications LED | 20 |
| Notification icons | 21 |
| Meter display language | 21 |
| Meter screen navigation | 21 |
| Navigation symbols | 22 |
| Meter screen menus overview | 22 |
| Setting up the display | 23 |
| Basic setup | 24 |
| Configuring basic setup parameters using the display | 24 |
| Configuring advanced setup parameters using the display | 26 |
| Setting the rate | 26 |
| Setting up regional settings | 27 |
| Setting up the screen passwords | 28 |
| Lost password | 28 |
| Setting the clock | 29 |
| SnapShot | 29 |
| Viewing SnapShot page | 29 |

| | |
|---|-----------|
| SnapShot setting | 30 |
| Retrofit | 30 |
| Retrofit setting | 30 |
| Configuring Favorite Page | 30 |
| Auto reset configuration | 31 |
| I/O Modules | 32 |
| Analog input applications | 32 |
| Analog output applications | 34 |
| Status input (DI) applications | 36 |
| Digital output applications | 37 |
| Relay output applications | 38 |
| IO LED Indicator | 40 |
| Alarms | 41 |
| Alarms overview | 41 |
| Alarm types | 41 |
| Unary alarms | 41 |
| Available unary alarms | 41 |
| Digital alarms | 41 |
| Available digital alarms | 42 |
| Standard alarms | 42 |
| Example of over and under setpoint (standard) alarm operation | 42 |
| Maximum allowable setpoint | 43 |
| Available standard alarms | 44 |
| Alarm priorities | 46 |
| Alarm setup overview | 46 |
| LED alarm indicator | 49 |
| Configuring the LED for alarms using the display | 49 |
| Configuring the LED for alarms using ION Setup | 49 |
| Alarm display and notification | 49 |
| Active alarms list and alarm history log | 50 |
| Alarms counters | 51 |
| Resetting alarms using ION Setup | 51 |
| Meter logging | 52 |
| Logs overview | 52 |
| Setting up the data log | 52 |
| Saving the data log contents using ION Setup | 52 |
| Alarm log | 53 |
| Measurements and calculations | 54 |
| Meter initialization | 54 |
| Real-time readings | 54 |
| Energy measurements | 54 |
| Quadrant based VARh | 54 |
| Min/max values | 55 |
| Power demand | 55 |
| Power demand calculation methods | 55 |
| Block interval demand | 55 |
| Synchronized demand | 56 |
| Thermal demand | 56 |
| Current demand | 57 |
| Predicted demand | 57 |

| | |
|--|-----------|
| Peak demand | 58 |
| Timer | 58 |
| Multi-tariff | 59 |
| Multi-tariff implementation | 59 |
| Command mode overview | 59 |
| Time of day mode overview | 60 |
| Time of day mode tariff validity | 60 |
| Time of day tariff creation methods | 60 |
| Example tariff configurations for a four-tariff system | 61 |
| Input mode overview | 61 |
| Digital input assignment for input control mode | 62 |
| Active tariff control mode | 62 |
| Configuring time of day mode tariffs using the display | 63 |
| Configuring input mode tariffs using the display | 64 |
| Power quality | 65 |
| Harmonics overview | 65 |
| Total harmonic distortion % | 65 |
| Harmonic content calculations | 65 |
| THD% calculations | 65 |
| Displaying harmonics data | 65 |
| Maintenance and upgrades | 67 |
| Maintenance overview | 67 |
| Troubleshooting LED indicators | 67 |
| Meter memory | 67 |
| Meter battery | 67 |
| Viewing firmware version, model and serial number | 68 |
| Firmware upgrades | 68 |
| Technical assistance | 68 |
| Verifying accuracy | 69 |
| Overview of meter accuracy | 69 |
| Accuracy test requirements | 69 |
| Verifying accuracy test | 70 |
| Required pulses calculation for accuracy verification testing | 71 |
| Total power calculation for accuracy verification testing | 72 |
| Percentage error calculation for accuracy verification testing | 72 |
| Accuracy verification test points | 72 |
| Energy pulsing considerations | 73 |
| VT and CT considerations | 73 |
| Example calculations | 74 |
| Typical sources of test errors | 75 |
| Power and power factor | 76 |
| Power and power factor | 76 |
| Current phase shift from voltage | 76 |
| Real, reactive and apparent power (PQS) | 76 |
| Power factor (PF) | 77 |
| Power factor sign convention | 77 |
| Power factor min/max convention | 78 |
| Power factor register format | 78 |
| Specifications | 80 |

Safety precautions

Installation, wiring, testing and service must be performed in accordance with all local and national electrical codes.

| |
|---|
| ⚠️⚠️ DANGER |
| <p>HAZARD OF ELECTRIC SHOCK, EXPLOSION, OR ARC FLASH</p> <ul style="list-style-type: none"> • Apply appropriate personal protective equipment (PPE) and follow safe electrical work practices. See NFPA 70E in the USA, CSA Z462 or applicable local standards. • Turn off all power supplying this device and the equipment in which it is installed before working on the device or equipment. • Always use a properly rated voltage sensing device to confirm that all power is off. • Follow guidelines in the Wiring section of the related Installation Sheet. • Treat communications and I/O wiring connected to multiple devices as hazardous live until determined otherwise. • Do not exceed the device's ratings for maximum limits. • Never short the secondary of a potential/voltage transformer (PT/VT). • Never open circuit a current transformer (CT). • Always use grounded external CTs for current inputs. • Do not use the data from the meter to confirm power is off. • Replace all devices, doors and covers before turning on power to this equipment. <p>Failure to follow these instructions will result in death or serious injury.</p> |

NOTE: See IEC 60950-1:2005, Annex W for more information on communications and I/O wiring connected to multiple devices.

| |
|--|
| ⚠️ WARNING |
| <p>UNINTENDED OPERATION</p> <ul style="list-style-type: none"> • Do not use this device for critical control or protection applications where human or equipment safety relies on the operation of the control circuit. • Do not use this device if a wrench icon appears on the top corner of the display screen or if the value under Meter Status is not "OK". <p>Failure to follow these instructions can result in death, serious injury, or equipment damage.</p> |

| |
|---|
| ⚠️ WARNING |
| <p>POTENTIAL COMPROMISE OF SYSTEM AVAILABILITY, INTEGRITY, AND CONFIDENTIALITY</p> <ul style="list-style-type: none"> • Change default passwords/passcodes to help prevent unauthorized access to device settings and information. • Disable unused ports/services and default accounts, where possible, to minimize pathways for malicious attacks. • Place networked devices behind multiple layers of cyber defenses (such as firewalls, network segmentation, and network intrusion detection and protection). • Use cybersecurity best practices (for example: least privilege, separation of duties) to help prevent unauthorized exposure, loss, modification of data and logs, interruption of services, or unintended operation. <p>Failure to follow these instructions can result in death, serious injury, or equipment damage.</p> |

Introduction

Meter overview

The PM2200 series meters are digital meters that offer comprehensive 3-phase electrical instrumentation and load management facilities in a compact and rugged package.

The meters offer value for the demanding needs of your energy monitoring and cost management applications. All meters in the PM2200 series range comply with Class 1, or Class 0.5S accuracy standards and feature high quality, reliability and affordability in a compact and easy to install format.

Meter Features

The PM2200 series meter supports many features, a few of the features are listed below:

- Self guided LCD display and navigation
- Energy accounting and balancing
- Measurement of both True PF and Displacement PF
- Active, reactive, and apparent energy readings
- Min/Max values of instantaneous parameters with timestamp.
- Cyber security: The meter enables disabling the RS-485 port through front panel keys against unauthorized access. This feature can also be used for toggling between the RTU devices in case of limited availability of nodes in software system.
- Snap: The meter feature includes a snapshot of average voltage, average current, total active power, and delivered energy.
- Suppression current: This is the minimum current at which the meter starts functioning. The meter can be configured to disregard the measurement of induced / auxiliary load current in the circuit. The suppression current selection can be done through the front display and through communication. The suppression current range is from 5 mA to 99 mA. The meter shows measurement if applied value is above the suppression value. The default suppression current is 5 mA.

You can use the meter as a stand-alone device, but its extensive capabilities are fully realized when used as part of an energy management system.

For applications, feature details and the most current and complete specifications of the PM2200 meters, see the EasyLogic PM2000 series technical datasheet at www.se.com.

Feature summary

| Parameter | PM2210 | PM2220 | PM2230 |
|---|---------|---------|------------|
| Accuracy Class for Wh | Class 1 | Class 1 | Class 0.5S |
| Accuracy Class for VARh | 1.0 | 1.0 | 1.0 |
| Sampling rate per cycle | 64 | 64 | 64 |
| Current: <ul style="list-style-type: none"> • Per-phase and 3 phase average • Calculated neutral current | ✓ | ✓ | ✓ |
| Voltage: <ul style="list-style-type: none"> • V L-N - per-phase and 3 phase average • V L-L - per-phase and 3 phase average | ✓ | ✓ | ✓ |

| Parameter | PM2210 | PM2220 | PM2230 |
|---|-------------------------|--|--|
| Power Factor <ul style="list-style-type: none"> Per phase and 3 phase total | True PF | True PF Displacement PF | True PF Displacement PF |
| Frequency | ✓ | ✓ | ✓ |
| Power: <ul style="list-style-type: none"> Active power (kW) - Phase wise and total Apparent power (kVA) - Phase wise and total Reactive power (kVAR) - Phase wise and total | ✓ | ✓ | ✓ |
| 3 Phase unbalance | Current | Current Voltage | Current Voltage |
| Demand parameters (kW, kVA, kVAR, I) <ul style="list-style-type: none"> Last demand Present demand Predictive demand Peak demand: Timestamp for peak demand ¹ | ✓ (no timestamp) | ✓ | ✓ |
| Energy: kWh, kVAh, kVARh (4 Quadrant) <ul style="list-style-type: none"> Delivered (Import / Forward) Received (Export / Reverse) | Delivered Received | Delivered Received Total ¹ Net ¹ Last cleared (Old) ¹ | Delivered Received Total ¹ Net ¹ Last cleared (Old) ¹ |
| THD: <ul style="list-style-type: none"> Voltage L-N Voltage L-L Current per phase | ✓ | ✓ | ✓ |
| Individual Harmonics | — | Up to 15th individual harmonics | Up to 31st individual harmonics |
| Min / Max with timestamp <ul style="list-style-type: none"> V L-L average V L-N average Current average Frequency Active power, Total Apparent power, Total Reactive power, Total Power factor, Total | — | ✓ | ✓ |
| Communication | POP | RS-485 Modbus RTU | RS-485 Modbus RTU |
| Expandable Analog IO modules (1 input & 1 output) | — | — | ✓ |
| Expandable Analog IO modules (2 inputs & 2 outputs) | — | — | ✓ |
| Expandable Digital IO modules (2 inputs & 2 outputs) | — | — | ✓ |
| Expandable Relay Output modules (2 digital input & 2 relay output) | — | — | ✓ |
| Data Logging <ul style="list-style-type: none"> Energy (W, VA, VAR): Delivered / Received Power: Active / Apparent / Reactive Demand (W, VA, VAR, A): Last / Present / Predictive | — | — | ✓ |
| Retrofit For configuring legacy communication data models. | — | ✓ | ✓ |
| Snap | — | ✓ | ✓ |
| Multi-tariff | — | — | ✓ |
| Auto reset ¹ | — | ✓ | ✓ |

1. Indicates features that can be read through communication only

Measured parameters

Energy

The meter provides bi-directional, 4-quadrant, Class 1 / Class 0.5S accurate energy metering.

The meter stores all accumulated active, reactive, and apparent energy parameters in nonvolatile memory:

- kWh, kVARh, kVAh (delivered)
- kWh, kVARh, kVAh (received)
- kWh, kVARh, kVAh (delivered + received)
- kWh, kVARh, kVAh (delivered - received)

NOTE: Based on the energy scale selection, when any of energy parameters overflow at 999.99 all energy parameters value resets.

Non Reset energy

Non Reset energy parameters are Wh, VAh and VARh for both Del and Rec. Non Reset energy parameters are available only on display in Diag page under Maintenance.

These parameter values cannot be reset either through display or through communication. These Non Reset energy values will overflow automatically when they reach max value based on overflow limit.

NOTE: Non Reset energy parameters can only be cleared using command Reset sub systems and meter initialization.

| Command | Accumulated energies | Non Reset energies | Old energies |
|--------------------------------|----------------------|--------------------|---|
| Reset sub systems | Clear | Clear | Clear |
| Initialization | Clear | Clear | Clear |
| Reset all energies | Clear | No clear | No clear (update with Accumulated energies) |
| Reset all accumulated energies | Clear | No clear | No clear (update with Accumulated energies) |

Demand

The meter provides last, present, predicted, and maximum (peak) demand values, and a timestamp when the maximum (peak) demand occurred.

The meter supports standard demand calculation methods, including sliding block, fixed block, rolling block, thermal and synchronized.

Peak demand registers can be reset manually (password protected).

Demand measurements include:

- W, VAR, VA demand total
- Amps demand average

Instantaneous

The meter provides highly accurate 1-second measurements, average values, including true RMS, per phase and total for:

- Per phase and average voltage (line-to-line, line-to-neutral)
- Per phase and average current, and neutral current

NOTE: Neutral current is calculated.

- Per phase and total power (VA, W, Var)
- Per phase and average for true and displacement power factor
- System frequency
- Per phase and maximum of all three for voltage unbalance and current unbalance

Power quality

The meter provides complete harmonic distortion metering, recording, and real-time reporting, up to the 15th harmonic for PM2220 and up to 31st harmonic for PM2230 for all voltage and current inputs.

The following power quality measurements are available:

- PM2220: Individual odd harmonics up to 15th order (Voltage and current, per phase)
- PM2230: Individual odd harmonics up to 31st order (Voltage and current, per phase)
- Total harmonic distortion (THD%) for current and voltage (displays line-to-line or line-to-neutral, based on selected system configuration)

Data recording

The meter stores each new minimum and new maximum value with date and timestamp for all instantaneous values and for each phase.

The meter also records the following:

- Alarms (with 1s timestamping)
- Parameters configured for data logging
- Data, alarm history, and diagnostics logs

Input/output

The meter supports optional input and output capabilities.

Other measurements

Additional measurements recorded by the meter include several timers.

These timers include:

- I/O timer displays the powered ON duration of the input or output.
- Operating timer displays the powered ON duration of the meter.
- Active load timer displays the duration of the connected load, based on the specified minimum current for the load timer setpoint setting.

Data display and analysis tools

Power Monitoring Expert

EcoStruxure™ Power Monitoring Expert is a complete supervisory software package for power management applications.

The software collects and organizes data gathered from your facility's electrical network and presents it as meaningful, actionable information via an intuitive web interface.

Power Monitoring Expert communicates with devices on the network to provide:

- Real-time monitoring through a multi-user web portal
- Trend graphing and aggregation
- Power quality analysis and compliance monitoring
- Preconfigured and custom reporting

See the EcoStruxure™ Power Monitoring Expert online help for instructions on how to add your device into its system for data collection and analysis.

Power SCADA Operation

EcoStruxure™ Power SCADA Operation is a complete real-time monitoring and control solution for large facility and critical infrastructure operations.

It communicates with your device for data acquisition and real-time control. You can use Power SCADA Operation for:

- System supervision
- Real-time and historical trending, event logging
- PC-based custom alarms

See the EcoStruxure™ Power SCADA Operation online help for instructions on how to add your device into its system for data collection and analysis.

Meter configuration

Meter configuration can be performed through the display or PowerLogic™ ION Setup.

ION Setup is a meter configuration tool that can be downloaded for free at www.se.com.

See the ION Setup online help or in the ION Setup device configuration guide. To download a copy, go to www.se.com and search for ION Setup device configuration guide.

Hardware references

PM2200 meter models and accessories

The meter is available in several different models with optional accessories that provide various mounting options.

Meter models

| Model | Commercial reference | Description |
|--------|----------------------|--|
| PM2210 | METSEPM2210 | Front panel mount, 96 x 96 mm form factor, EasyLogic VAF Power and Energy meter with THD and POP. Complies with accuracy class 1. |
| PM2220 | METSEPM2220 | Front panel mount, 96 x 96 mm form factor, EasyLogic VAF Power and Energy meter with RS-485 communication and odd harmonics up to 15 th order. Complies with accuracy class 1. |
| PM2230 | METSEPM2230 | Front panel mount, 96 x 96 mm form factor, EasyLogic VAF Power and Energy meter with RS-485 communication and odd harmonics up to 31 st order. Complies with accuracy class 0.5S. |

Meter accessories

| Model | Commercial reference | Description |
|---|--|--|
| 2 Channel Digital Input Output Module | METSEPM2KDGTLIO22 and METSEPM2KDGTLIO22D | Digital I/O module with 2 channel input and output. |
| 2 Channel Analog Input Output Module | METSEPM2KANLGIO22 and METSEPM2KANLGIO22D | Analog I/O module with 2 channel input and output. |
| 1 Channel Analog Input Output Module | METSEPM2KANLGIO11 and METSEPM2KANLGIO11D | Analog I/O module with single channel input and output. |
| 2 Channel Digital Input and Relay Output Module | METSEPM2K2DI2RO and METSEPM2K2DI2ROD | Relay module with dual channel digital input and relay output. |

NOTE: The I/O modules are supported by PM2230 meter models only.

See the PM2000 series catalog pages, available from www.se.com, or consult your local Schneider Electric representative for information about mounting adapters available for your meter.

Supplemental information

This document is intended to be used in conjunction with the installation sheet that ships in the box with your device and accessories.

See your device's installation sheet for information related to installation.

See your product's catalog pages at www.se.com for information about your device, its options and accessories.

You can download updated documentation from www.se.com or contact your local Schneider Electric representative for the latest information about your product.

Meter wiring considerations

Direct connect voltage limits

You can connect the meter's voltage inputs directly to the phase voltage lines of the power system if the power system's line-to-line or line-to-neutral voltages do not exceed the meter's direct connect maximum voltage limits.

The meter's voltage measurement inputs are rated by the manufacturer for up to 277 V L-N / 480 V L-L. However, the maximum voltage allowed for direct connection may be lower, depending on the local electrical codes and regulations. As per installation category II / III the maximum voltage on the meter voltage measurement inputs should not exceed 277 V L-N / 480 V L-L for CAT III and 347 V L-N / 600 V L-L for CAT II.

If your system voltage is greater than the specified direct connect maximum voltage, you must use VTs (voltage transformers) to step down the voltages.

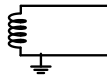
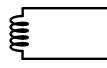
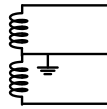
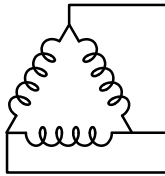
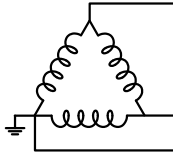
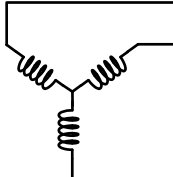
| Power system description | Meter setting | | Symbol | Direct connect maximum (UL / IEC) | | # of VTs (if required) |
|---|--------------------|---------------------------------|---|-----------------------------------|--------------------------|------------------------|
| | Display (meter) | Display (communication) | | Installation category III | Installation category II | |
| Single-phase 2-wire line-to-neutral | 1PH2W LN | 1PH 2Wire L-N |  | ≤ 277 V L-N | ≤ 347 V L-N | 1 VT |
| Single-phase 2-wire line-to-line | 1PH2W LL | 1PH 2Wire L-L |  | 480 V L-L | 600 V L-L | 1 VT |
| Single-phase 3-wire line-to-line with neutral | 1PH3W LL With N | 1PH 3Wire L-L with N |  | ≤ 277 V L-N / 480 V L-L | ≤ 347 V L-N / 600 V L-L | 2 VT |
| 3-phase 3-wire Delta ungrounded | 3PH3W Dlt Ungnd | 3PH 3Wire Ungrounded Delta |  | 480 V L-L | 600 V L-L | 2 VT |
| 3-phase 3-wire Delta corner grounded | 3PH3W Dlt Crnr Gnd | 3PH 3Wire Corner Grounded Delta |  | 480 V L-L | 600 V L-L | 2 VT |
| 3-phase 3-wire Wye ungrounded | 3PH3W Wye Ungnd | 3PH 3Wire Ungrounded Wye |  | 480 V L-L | 600 V L-L | 2 VT |

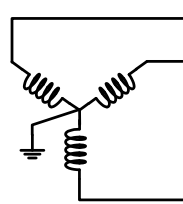
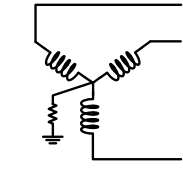
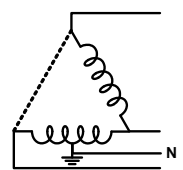
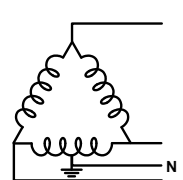
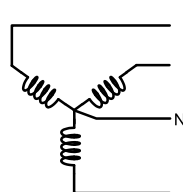
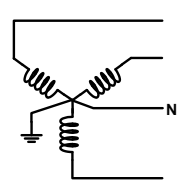
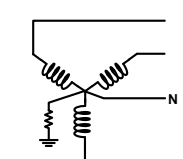
| Power system description | Meter setting | | Symbol | Direct connect maximum (UL / IEC) | | # of VTs (if required) |
|---|----------------------|------------------------------------|---|-----------------------------------|--------------------------|------------------------|
| | Display (meter) | Display (communication) | | Installation category III | Installation category II | |
| 3-phase 3-wire Wye grounded | 3PH3W Wye Gnd | 3PH 3Wire Grounded Wye |  | 480 V L-L | 600 V L-L | 2 VT |
| 3-phase 3-wire Wye resistance-grounded | 3PH3W Wye Res Gnd | 3PH 3Wire Resistance Grounded Wye |  | 480 V L-L | 600 V L-L | 2 VT |
| 3-phase 4-wire open Delta center-tapped | 3PH4W Opn Dlt Ctr Tp | 3PH 4Wire Center-Tapped Open Delta |  | 240 V L-N / 480 V L-L | 240 V L-N / 480 V L-L | 3 VT |
| 3-phase 4-wire Delta center-tapped | 3PH4W Dlt Ctr Tp | 3PH 4Wire Center-Tapped Delta |  | 240 V L-N / 480 V L-L | 240 V L-N / 480 V L-L | 3 VT |
| 3-phase 4-wire ungrounded Wye | 3PH4W Wye Ungnd | 3PH 4Wire Ungrounded Wye |  | ≤ 277 V L-N / 480 V L-L | ≤ 347 V L-N / 600 V L-L | 3 VT or 2 VT |
| 3-phase 4-wire grounded Wye | 3PH4W Wye Gnd | 3PH 4Wire Grounded Wye |  | ≤ 277 V L-N / 480 V L-L | ≤ 347 V L-N / 600 V L-L | 3 VT or 2 VT |
| 3-phase 4-wire resistance-grounded Wye | 3PH4W Wye Res Gnd | 3PH 4Wire Resistance Grounded Wye |  | ≤ 277 V L-N / 480 V L-L | ≤ 347 V L-N / 600 V L-L | 3 VT or 2 VT |

Balanced system considerations

In situations where you are monitoring a balanced 3-phase load, you may choose to connect only one or two CTs on the phase(s) you want to measure, and then configure the meter so it calculates the current on the unconnected current input(s).

NOTE: For a balanced 4-wire Wye system, the meter's calculations assume that there is no current flowing through the neutral conductor.

Balanced 3-phase Wye system with 2 CTs

The current for the unconnected current input is calculated so that the vector sum for all three phases equal zero.

Balanced 3-phase Wye or Delta system with 1CT

The currents for the unconnected current inputs are calculated so that their magnitude and phase angle are identical and equally distributed, and the vector sum for all three phase currents equal zero.

NOTE: You must always use 3 CTs for 3-phase 4-wire center-tapped Delta or center-tapped open Delta systems.

RS-485 wiring

Connect the devices on the RS-485 bus in a point-to-point configuration, with the (+) and (-) terminals from one device connected to the corresponding (+) and (-) terminals on the next device.

RS-485 cable

Use a shielded 2 twisted pair or 1.5 twisted pair RS-485 cable to wire the devices. Use one twisted pair to connect the (+) and (-) terminals, and use the other insulated wire to connect the C terminals

The total distance for devices connected on an RS-485 bus should not exceed 1000 m (3280 ft).

RS-485 terminals

| | |
|---|---|
| C | Common. This provides the voltage reference (zero volts) for the data plus and data minus signals |
|  | Shield. Connect the bare wire to this terminal to help suppress signal noise that may be present. Ground the shield wiring at one end only (either at the master or the last slave device, but not both). |
| - | Data minus. This transmits/receives the inverting data signals. |
| + | Data plus. This transmits/receives the non-inverting data signals. |

NOTE: If some devices in your RS-485 network do not have the C terminal, use the bare wire in the RS-485 cable to connect the C terminal from the meter to the shield terminal on the devices that do not have the C terminal.

Pulse output

The meter is equipped with one pulse output port (D1+, D1-).

You can configure the pulse outputs for use in the following application:

- energy pulsing applications, where a receiving device determines energy usage by counting the k_h pulses coming from the meter's pulse output port.

One pulse output can handle voltage less than or equal to 40 V DC (20 mA maximum). For higher voltage applications, use an external relay in the switching circuit.

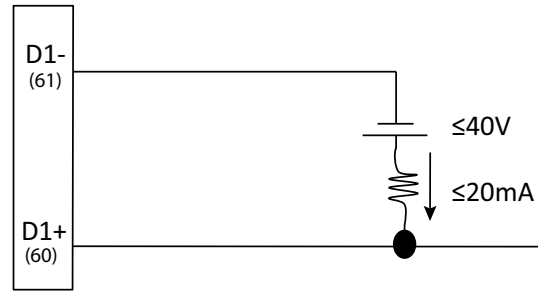

Meter display

Display overview

The display (integrated or remote) lets you use the meter to perform various tasks such as setting up the meter, displaying data screens, acknowledging alarms, or performing resets.

| | |
|---|--|
| A | Navigation / menu selection buttons |
| B | Heartbeat / communications LED (green) |
| C | Alarm / energy pulsing LED (orange) |
| D | Navigation symbols or menu options |
| E | Right notification area |
| F | Screen title |
| G | Left notification area |
| H | Cursor |

LED indicators

The LED indicators alert or inform you of meter activity.

| | |
|---|---------------------------------------|
| A | Alarm / energy pulsing LED |
| B | Heartbeat / serial communications LED |

Alarm / energy pulsing LED

The alarm / energy pulsing LED can be configured for alarm notification or energy pulsing.

When configured for alarm notification, this LED blinks every one second indicating that a high, medium or low priority alarm is tripped. The LED provides a visual indication of an active alarm condition or an inactive but unacknowledged high priority alarm.

When configured for energy pulsing, this LED flashes at a rate proportional to the amount of energy consumed. This is typically used to verify the power meter's accuracy.

Heartbeat / serial communications LED

The heartbeat / serial communications LED blinks to indicate the meter's operation and serial Modbus communications status.



The LED blinks at a slow, steady rate to indicate the meter is operational. The LED flashes at a variable, faster rate when the meter is communicating over a Modbus serial communications port.

You cannot configure this LED for other purposes.

NOTE: A heartbeat LED that remains lit and does not blink (or flash) can indicate a hardware problem.

Notification icons

To alert you about meter state or events, notification icons appear at the top left or top right corner of the display screen.

| Icon | Description |
|---|---|
|  | The wrench icon indicates that the power meter is in an overvoltage condition or requires maintenance. It could also indicate that the energy LED is in an overrun state. |
|  | The alarm icon indicates an alarm condition has occurred. |

Meter display language

If your meter is equipped with a display screen, you can configure the meter to display the measurements in one of several languages.

The following languages are available:

- English
- French
- Spanish
- German
- Portuguese
- Russian
- Chinese
- Turkish

Meter screen navigation

The meter’s buttons and display screen allow you to navigate data and setup screens, and to configure the meter’s setup parameters.

A. Press the button below the appropriate menu to view that screen

B. Press the right arrow to view more screens

C. In setup mode, a small right arrow indicates the selected option

D. In setup mode, a small down arrow indicates that there are additional parameters to display. The down arrow disappears when there are no more parameters to display.

E. In setup mode, press the button under **Edit** to change that setting. If the item is read-only, cannot be configured with the meter's existing setup, or can only be configured using software, **Edit** disappears.

Navigation symbols

Navigation symbols indicate the functions of the associated buttons on your meter's display.

| Symbol | Description | Actions |
|--------|------------------|--|
| ▶ | Right arrow | Scroll right and display more menu items or move cursor one character to the right |
| ▲ | Up arrow | Exit screen and go up one level |
| ▼ | Small down arrow | Move cursor down the list of options or display more items below |
| ▲ | Small up arrow | Move cursor up the list of items or display more items above |
| ◀ | Left arrow | Move cursor one character to the left |
| + | Plus sign | Increase the highlighted value or show the next item in the list. |
| - | Minus sign | Show the previous item in the list |

When you reach the last screen, press the right arrow again to cycle through the screen menus.

Meter screen menus overview

All meter screens are grouped logically, according to their function.

You can access any available meter screen by first selecting the Level 1 (top level) screen that contains it.

Level 1 screen menus - IEEE title [IEC title]

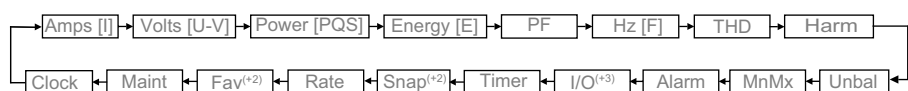

(+2)Applicable only for PM2220/PM2230 meter models

(+3)Applicable only for PM2230 meter model

Setting up the display

You can change the display screen’s settings, such as contrast, backlight timeout, and screen timeout .

1. Navigate to **Maint > Setup**.
2. Enter the setup password (default is “0”), then press **OK**.
3. Navigate to **HMI > Disp**.
4. Move the cursor to point to the parameter you want to modify, then press **Edit**.
5. Modify the parameter as required, then press **OK**.
6. Move the cursor to point to the next parameter you want to modify, press **Edit**, make your changes, then press **OK**.
7. Press the up arrow to exit.
8. Press **Yes** to save your changes.

Display settings available using the display

| Parameter | Values | Description |
|-----------------------|--------|---|
| Contrast | 1 - 9 | Increase or decrease the value to increase or decrease the display contrast. |
| Bcklght Timeout (min) | 0 - 60 | Set how long (in minutes) before the backlight turns off after a period of inactivity. Setting this to “0” disables the backlight timeout feature (i.e., backlight is always on). |
| Screen Timeout (min) | 0 - 60 | Set how long (in minutes) before the screen turns off after a period of inactivity. Setting this to “0” disables the screen timeout feature (i.e., display is always on). |

To configure the display using ION Setup, see the “PM2000” topic in the ION Setup online help or in the ION Setup device configuration guide, available for download at www.se.com.

Basic setup

Configuring basic setup parameters using the display

You can configure basic meter parameters using the display.

Proper configuration of the meter's basic setup parameters is essential for accurate measurement and calculations. Use the Basic Setup screen to define the electrical power system that the meter is monitoring.

If standard (1-sec) alarms have been configured and you make subsequent changes to the meter's basic setup, all alarms are disabled to prevent undesired alarm operation.

NOTICE

UNINTENDED EQUIPMENT OPERATION

- Verify all standard alarms settings are correct and make adjustments as necessary.
- Re-enable all configured alarms.

Failure to follow these instructions can result in equipment damage.

After saving the changes, confirm all configured standard alarm settings are still valid, reconfigure them as required, and re-enable the alarms.

1. Navigate to **Maint > Setup**.
2. Enter the setup password (default is "0"), then press **OK**.
3. Navigate to **Meter > Basic**.
4. Move the cursor to point to the parameter you want to modify, then press **Edit**.
5. Modify the parameter as required, then press **OK**.
6. Move the cursor to point to the next parameter you want to modify, press **Edit**, make your changes, then press **OK**.

7. Press **Yes** to save your changes.**Basic setup parameters available using the display**

| Values | Description |
|--|---|
| Power System | |
| Select the power system type (power transformer) the meter is wired to. | |
| 1PH2W LN | Single-phase 2-wire line-to-neutral |
| 1PH2W LL | Single-phase 2-wire line-to-line |
| 1PH3W LL with N | Single-phase 3-wire line-to-line with neutral |
| 3PH3W Dlt Ungnd | 3-phase 3-wire ungrounded delta |
| 3PH3W Dlt Crnr Gnd | 3-phase 3-wire corner grounded delta |
| 3PH3W Wye Ungnd | 3-phase 3-wire ungrounded wye |
| 3PH3W Wye Gnd | 3-phase 3-wire grounded wye |
| 3PH3W Wye Res Gnd | 3-phase 3-wire resistance-grounded wye |
| 3PH4W Opn Dlt Ctr Tp | 3-phase 4-wire center-tapped open delta |
| 3PH4W Dlt Ctr Tp | 3-phase 4-wire center-tapped delta |
| 3PH4W Wye Ungnd | 3-phase 4-wire ungrounded wye |
| 3PH4W Wye Gnd | 3-phase 4-wire grounded wye |
| 3PH4W Wye Res Gnd | 3-phase 4-wire resistance-grounded wye |
| VT Connect | |
| Select how many voltage transformers (VT) are connected to the electrical power system. | |
| Direct Con | Direct connect; no VTs used |
| 2VT | 2 voltage transformers |
| 3VT | 3 voltage transformers |
| VT Primary (V) | |
| 1 to 1,000,000 | Enter the size of the VT primary, in Volts. |
| VT Secondary (V) | |
| 100, 110, 115, 120 | Select the size of the VT secondary, in Volts. |
| CT on Terminal | |
| Define how many current transformers (CT) are connected to the meter, and which terminals they are connected to. | |
| I1 | 1 CT connected to I1 terminal |
| I2 | 1 CT connected to I2 terminal |
| I3 | 1 CT connected to I3 terminal |
| I1 I2 | 2 CT connected to I1, I2 terminals |
| I2 I3 | 2 CT connected to I1, I3 terminals |
| I1 I3 | 2 CT connected to I2, I3 terminals |
| I1 I2 I3 | 3 CT connected to I1, I2, I3 terminals |
| CT Primary (A) | |
| 1 to 32767 | Enter the size of the CT primary, in Amps. |
| CT Secondary (A) | |
| 1, 5 | Select the size of the CT secondary, in Amps. |
| Sys Frequency (Hz) | |
| 50, 60 | Select the frequency of the electrical power system, in Hz. |
| Phase Rotation | |
| ABC, CBA | Select the phase rotation of the 3-phase system. |

Basic setup parameters available using the display (Continued)

| Values | Description |
|---|---|
| A.Suppression This is the minimum current at which the meter starts functioning. The meter can be configured to disregard the measurement of induced / auxiliary load current in the circuit. | |
| 5 to 99 | Select the Threshold Current (Suppression Current), in mA. NOTE: The default suppression current is 5 mA. |

Configuring advanced setup parameters using the display

You can configure a subset of advanced parameters using the display.

1. Navigate to **Maint > Setup**.
2. Enter the setup password (default is "0"), then press **OK**.
3. Navigate to **Meter > Advan**.
4. Move the cursor to point to the parameter you want to modify, then press **Edit**.
5. Modify the parameter as required, then press **OK**.
6. Move the cursor to point to the next parameter you want to modify, press **Edit**, make your changes, then press **OK**.
7. Press **Yes** to save your changes.

Advanced setup parameters available using the display

| Parameter | Values | Description |
|----------------------|--------|--|
| Label | — | This label identifies the device, e.g., "Power Meter". You cannot use the display to edit this parameter. Use ION Setup to change the device label. |
| Load Timer Setpt (A) | 0 - 18 | Specifies the minimum average current at the load before the timer starts. The meter begins counting the number of seconds the load timer is on (i.e., whenever the readings are equal to or above this average current threshold). |
| Pk I dmd for TDD (A) | 0 - 18 | Specifies the minimum peak current demand at the load for inclusion in total demand distortion (TDD) calculations. If the load current is below the minimum peak current demand threshold, the meter does not use the readings to calculate TDD. Set this to "0" (zero) if you want the power meter to use the metered peak current demand for this calculation. |

Setting the rate

The Rate setup screens allow you to set the different rate parameters.

1. Navigate to **Maint > Setup**.
2. Enter the setup password (default is "0"), then press **OK**.
3. Navigate to **Rate**.
4. Move the cursor to point to **Rate1** or **Rate2** to modify, then press **Edit**.
5. Move the cursor to point to **Channel** or **Factor per (k__h)** to modify, then press **Edit**.
6. Modify the parameter as required, then press **OK**.
7. Press up arrow and press **Yes** to save your changes.

8. Press the up arrow to exit.

| Parameter | Values | Description |
|-------------------|--|---|
| Label | Rate1 / Rate2 Example: CO2 Emission, Energy Cost | You can edit the label using ION Setup |
| Channel | None, Active Del, Active Rec, Active Del + Rec, Reactive Del, Reactive Rec, Reactive Del + Rec, Apparent Del, Apparent Rec, Apparent Del + Rec | Select a channel from the list. |
| Factor per (k__h) | 0.000 to 99999.999 | You can edit the factor value between 0.000 to 99999.999. |

To configure the Rate using ION Setup, see the “PM2000 series meter” topic in the ION Setup online help or in the ION Setup device configuration guide, available for download at www.se.com.

Setting up regional settings

You can change the regional settings to localize the meter screens and display data in a different language, using local standards and conventions.

NOTE: In order to display a different language other than those listed in the Language setup parameter, you need to download the appropriate language file to the meter using the firmware upgrade process.

1. Navigate to **Maint > Setup**.
2. Enter the setup password (default is “0”), then press **OK**.
3. Navigate to **HMI > Region**.
4. Move the cursor to point to the parameter you want to modify, then press **Edit**.
5. Modify the parameter as required, then press **OK**.
6. Move the cursor to point to the next parameter you want to modify, press **Edit**, make your changes, then press **OK**.
7. Press the up arrow to exit.

- Press **Yes** to save your changes.

Regional settings available using the display

| Parameter | Values | Description |
|-------------|---|---|
| Language | English US, French, Spanish, German, Portuguese, Chinese, Russian and Turkish | Select the language you want the meter to display. |
| Date Format | MM/DD/YY, YY/MM/DD, DD/MM/YY | Set how you want the date to be displayed, e.g., month/day/year. |
| Time Format | 24Hr, AM/PM | Set how you want the time to be displayed, e.g., 17:00:00 or 5:00:00 PM. |
| HMI Mode | IEC, IEEE | Select the standards convention used to display menu names or meter data. |

Setting up the screen passwords

It is recommended that you change the default password in order to prevent unauthorized personnel from accessing password-protected screens such as the diagnostics and reset screens.

This can only be configured through the front panel. The factory-default setting for all passwords is "0" (zero).

- Navigate to **Maint > Setup**.
- Enter the setup password (default is "0"), then press **OK**.
- Navigate to **HMI > Pass**.
- Move the cursor to point to the parameter you want to modify, then press **Edit**.

| Parameter | Values | Description |
|----------------|-------------|--|
| Setup | 0000 - 9999 | Sets the password for accessing the meter setup screens (Maint > Setup). |
| Energy Resets | 0000 - 9999 | Sets the password for resetting the meter's accumulated energy values. |
| Demand Resets | 0000 - 9999 | Sets the password for resetting the meter's recorded peak demand values. |
| Min/Max Resets | 0000 - 9999 | Sets the password for resetting the meter's recorded minimum and maximum values. |

- Modify the parameter as required, then press **OK**.
- Move the cursor to point to the next parameter you want to modify, press **Edit**, make your changes, then press **OK**.
- Press the up arrow to exit.
- Press **Yes** to save your changes.

Lost password

Visit www.se.com for support and assistance with lost passwords or other technical problems with the meter.

Make sure you include your meter's model, serial number and firmware version in your email or have it readily available if calling Technical Support.

Setting the clock

The Clock setup screens allow you to set the meter's date and time.

1. Navigate to **Maint > Setup**.
2. Enter the setup password (default is "0"), then press **OK**.
3. Navigate to **Clock**.
4. Move the cursor to point to the parameter you want to modify, then press **Edit**.
5. Modify the parameter as required, then press **OK**.
6. Press **Yes** to save your changes.
7. Move the cursor to point to the next parameter you want to modify, press **Edit**, make your changes, then press **OK**.
8. Press the up arrow to exit.
9. Press **Yes** to save your changes.

| Parameter | Values | Description |
|------------|---|--|
| Date | DD/MM/YY, MM/DD/YY, YY/ MM/DD | Set the current date using the format displayed on screen, where DD = day, MM = month and YY = year. |
| Time | HH:MM:SS (24 hour format), HH:MM:SS AM or PM | Use the 24-hour format to set the current time in UTC (GMT). |
| Meter Time | GMT, Local | Select GMT to display the current time in UTC (Greenwich Mean Time zone). To display local time, set this parameter to Local, then use GMT Offset (h) to display local time in the proper time zone. |

To configure the clock using ION Setup, see the "PM2000 series meter" topic in the ION Setup online help or in the ION Setup device configuration guide, available for download at www.se.com.

SnapShot

NOTE: Applicable only for PM2220/PM2230 meter models

The meter supports recording of instantaneous values through snapshot using HMI. This page enables capturing values of Voltage Average (Vavg), Current Average (Iavg), Power Total (Ptot), and Energy Delivered (E Del). The time of recording is defined by the time set for the snapshot feature. This can be configured using HMI or ION Setup.

Viewing SnapShot page

1. Navigate to **Snap**.
2. Press **Snap** to view parameter values. SnapShot page displays below parameters:
 - Voltage Average (Vavg)
 - Current Average (Iavg)
 - Power Total (Ptot)
 - Energy Delivered (E Del)
3. Press **SnpDT** to view the SnapShot time in HH:MM and date.

SnapShot setting

1. Navigate to **Maint > Setup**.
2. Enter the setup password (default is "0"), then press **OK**.
3. Navigate to **Snap**.
4. Press **Snap**. The SnapShot screen appears.
5. Press **Edit** to select the SnapShot time in HH:MM.
6. Press **+** to increment the active digit through the numerals 0-9.
7. Press **◀** to enter the selected character and move to the character on the left.
8. Continue until all values are selected, then press **OK** to set the time.
 - Press **Yes** to accept the changes and return to the previous screen.
 - Press **No** to keep the existing configuration and return to the previous screen.

Retrofit

NOTE: Applicable only for PM2220/PM2230 meter models

The retrofit in the meter provides you an option for configuring legacy data models to communicate with the new models. The retrofit register map selection can be configured using HMI.

Retrofit setting

The following settings are required to enable the **Retrofit** communication mode in the meter.

1. Navigate to **Maint > Setup**.
2. Enter the setup password (default is "0"), then press **OK**.
3. Press **Comm**. The Serial Port screen appears.
4. Press **Edit** to select the **Accumulated** parameter.
5. Press **-** or **+** to scroll to **Retrofit**.
6. Press **OK** to select the **Retrofit** configuration.
7. Press **▲** to return to the setup screen.
 - NOTE:** The existing configuration will be lost when you make new selection, so a confirmation screen appears.
 - Press **Yes** to accept the changes and return to the Setup screen.
 - Press **No** to keep the existing configuration and return to the Setup screen.

Configuring Favorite Page

NOTE: Applicable only for PM2220/PM2230 meter models

The meter allows you to select 4 parameters and arrange them in required order to be displayed in favorite page. These parameters can be selected only through communication and are customer based requirements. Some parameter logs are of utmost importance and navigating to those parameters takes time. For ease of navigation and accessibility, the meter allows you to choose 4 parameters and lock the page for easy reading.

The default Favorite Page parameters are:

- Aavg
 - PFavg
 - Ptot
 - E.Del
1. Start ION Setup and connect to your meter.
 2. Open **I/O Setup** and select the required parameter you want to configure.
 3. Configure the parameter and click **OK**.

Below is the list of associated parameters which can be configured:

- Current Average (Iavg)
- Voltage L-L average (Vavg)
- Voltage L-N average (Vavg)
- Active Power total (Wtot)
- Reactive Power total (VARtot)
- Apparent Power total (VAtot)
- Power Factor Average (PFavg)
- Frequency (F)
- Active Energy – Del (Wh-Del)
- Reactive Energy – Del (VARh-Del)
- Apparent Energy - Del (VAh-Del)

Auto reset configuration

NOTE: Applicable only for PM2220/PM2230 meter models

Auto Reset feature enables the user to reset the Energy and Demand parameters on a pre-programmed date and month (DD/MM). Month wise reset dates for 12 months can be configured.

On executing Auto Reset for Energy and Maximum Demand for those configured date and month (DD/MM), the Energy parameters (VAh, Wh, VARh (Del, Rec, D-R, D+R)) will be transferred to OLD registers. Both Energy and Maximum Demand will reset to 0. When Energy is cleared, Max Demand is also cleared automatically.

Auto Reset for Energy and Maximum Demand parameters can be configured only through communication.

I/O Modules

Applicable only for PM2230 meter model

This section supplements the optional I/O module installation sheets and provides additional information regarding physical characteristics and capabilities of the I/O module.

The I/O modules are available in the following variants:

- Single channel analog I/O module
- Two channel analog I/O module
- Two channel digital I/O module
- Two channel digital input and relay output module

Analog input applications

The analog inputs interpret an incoming analog current signal from transducers. The analog I/O module can measure current using standard 4 - 20 mA analog transducers.

For analog input operation, the meter takes an analog input signal and provides the resulting scaled value. Analog inputs may show a value below zero scale if an open circuit is detected on the input port.

You can set the analog input's mode for current sensing.

Wiring the analog input

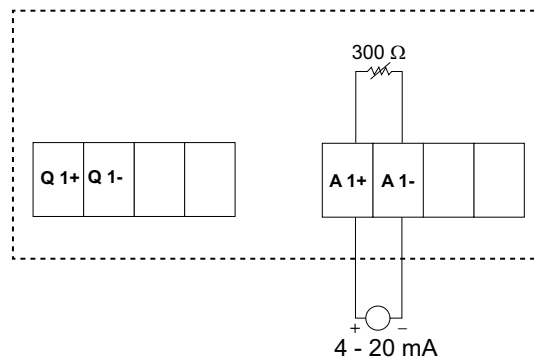

Wiring the dual analog inputs

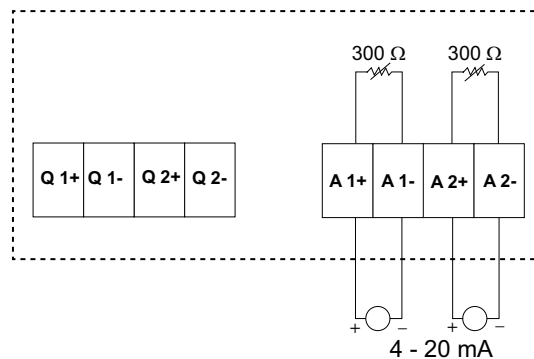

You can configure the following analog inputs on your meter:

| Code | Unit | Description |
|------|------|-------------|
| 0 | – | No units |
| 1 | % | Percentage |

| Code | Unit | Description |
|------|--------------|--------------------------------|
| 2 | °C | Degrees Celsius |
| 3 | °F | Degrees Fahrenheit |
| 4 | Deg | Degrees Angular |
| 5 | Hz | Hertz |
| 6 | A | Amperes |
| 7 | kA | Kilo Amperes |
| 8 | V | Volts |
| 9 | kV | Kilo Volts |
| 10 | MV | Mega Volts |
| 11 | W | Watts |
| 12 | kW | Kilowatts |
| 13 | MW | Megawatts |
| 14 | VAR | Volt-Ampere Reactive |
| 15 | kVAR | Kilo Volt-Ampere Reactive |
| 16 | MVAR | Mega Volt-Ampere Reactive |
| 17 | VA | Volt-Amperes |
| 18 | kVA | Kilo Volt-Amperes |
| 19 | MVA | Mega Volt-Amperes |
| 20 | WH | Watt-Hour |
| 21 | kWH | Kilowatt-Hour |
| 22 | MWH | Megawatt-Hour |
| 23 | VARH | Reactive Volt-Ampere Hour |
| 24 | kVARH | Reactive Kilo Volt-Ampere Hour |
| 25 | MVARH | Reactive Mega Volt-Ampere Hour |
| 26 | VAH | Volt-Ampere Hours |
| 27 | kVAH | Kilo Volt-Ampere Hours |
| 28 | MVAH | Mega Volt-Ampere Hours |
| 29 | Seconds | Seconds |
| 30 | Minutes | Minutes |
| 31 | Hours | Hours |
| 32 | Bytes (RAM) | Bytes |
| 33 | kBytes (RAM) | Kilobytes |
| 34 | \$ | Dollars |
| 35 | gal | Gallons |
| 36 | gal/hr | Gallons/hour |
| 37 | gal/min | Gallons/minute |
| 38 | cfm | Cubic feet/min |
| 39 | PSI | PSI |
| 40 | BTU | BTU |
| 41 | L | Liters |
| 42 | ton-hours | Ton-hours |
| 43 | l/hr | Liters/hour |
| 44 | l/min | Liters/min |
| 45 | € | Euros |

| Code | Unit | Description |
|------|-------------------------------|---|
| 46 | ms | Milliseconds |
| 47 | m ³ | Cubic-meters |
| 48 | m ³ /sec | Cubic-meters/sec |
| 49 | m ³ /min | Cubic-meters/min |
| 50 | m ³ /hr | Cubic-meters/hour |
| 51 | Pa | Pascals |
| 52 | Bars | Bar |
| 53 | RPM | Revolutions/min |
| 55 | BTU/hr | BTU/hour |
| 56 | PSIG | Pounds/square inch gauge |
| 57 | SCFM | Standard cubic feet/min |
| 58 | MCF | Thousand cubic feet |
| 59 | Therm | Therm |
| 60 | SCFH | Standard cubic feet/hour |
| 61 | PSIA | Pounds/square inch absolute |
| 62 | lbs | Pounds |
| 63 | kg | Kilogram |
| 64 | klbs | Kilopounds |
| 65 | lb/hr | Pound/hour |
| 66 | ton/hr | Ton/hour |
| 67 | kg/hr | Kilogram/hour |
| 68 | in. Hg | Inch of Mercury |
| 69 | kPa | KiloPascals |
| 70 | %RH | Percentage of relative humidity |
| 71 | MPH | Miles per hour |
| 72 | m/sec | Meters/sec |
| 73 | mV/cal/(cm ² /min) | MilliVolts/calorie/(square centimeters/min) |
| 74 | in | Inches |
| 75 | mm | Millimeter |
| 76 | GWH | GigaWatt-Hour |
| 77 | GVARH | Reactive Giga Volt-Ampere Hour |
| 78 | GVAH | Giga Volt-Ampere Hours |
| 79 | AH | Ampere-Hours |
| 80 | KAH | Kiloamp-Hours |
| 81 | Therm/hr | Therm/hour |

Analog output applications

The analog I/O module can send low current using standard 4 - 20 mA analog transducers.

For analog output operation, the meter takes an input value and scales it to the appropriate signal value to send out the physical analog output port.

Wiring the analog output

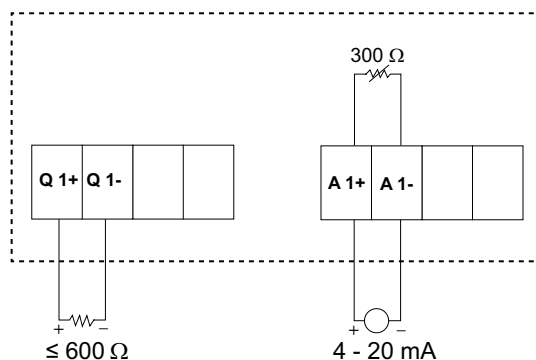

Wiring the dual analog output

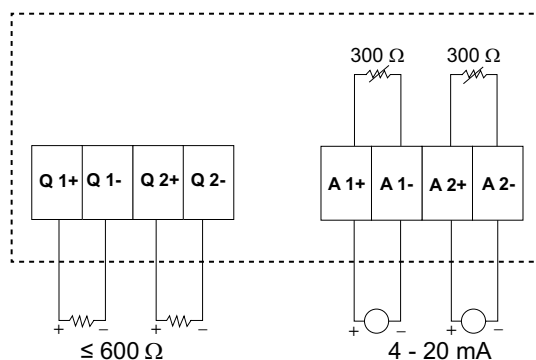

You can configure the following analog outputs on your meter:

| Parameters | Description |
|------------|-----------------------------------|
| Current | Current: Phase wise |
| | Current Average |
| | Current Unbalance: Phase wise |
| | Current Unbalance Worst |
| Voltage | Voltage L-L: Phase wise |
| | Voltage L-L Avg |
| | Voltage L-N: Phase wise |
| | Voltage L-N Avg |
| | Voltage Unbalance L-L: Phase wise |
| | Voltage Unbalance L-L Worst |
| | Voltage Unbalance L-N: Phase wise |
| | Voltage Unbalance L-N Worst |
| Power | Active Power: Phase wise |
| | Active Power Total |
| | Reactive Power: Phase wise |
| | Reactive Power Total |
| | Apparent Power: phase wise |
| | Apparent Power Total |
| PF | PF Total |
| Frequency | Frequency |

Status input (DI) applications

Status inputs are typically used for monitoring the status of external contacts or circuit breakers and multi-tariff applications.

The meter's status inputs require either an external voltage source or whetting voltage (provided in the meter) to detect the status input's ON/OFF state. The meter detects an ON state if the external voltage appearing at the status input is within its operating range.

Wiring the status inputs

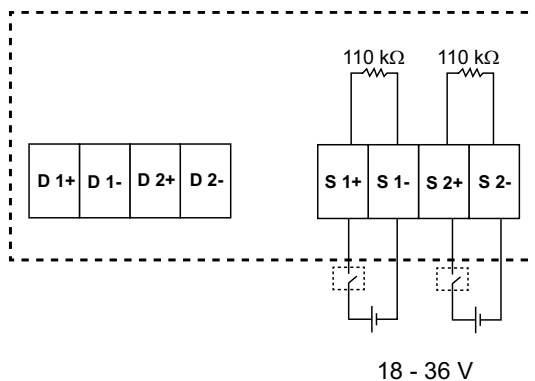

Configuring status inputs using ION Setup

The status input ports (S1 and S2) can be configured using ION Setup.

1. Start ION Setup.
2. Connect to your meter.
3. Navigate to **I/O configuration > I/O Setup**.
4. Select a status input to configure and click **Edit**.
The setup screen for that status input is displayed.
5. Enter a descriptive name for the status input's **Label**.
6. Configure the other setup parameters as required.
7. Click **Send** to save your changes.

Status input setup parameters available through ION Setup

| Parameter | Values | Description |
|--------------|---------------------|---|
| Label | — | Use this field to change the default label and assign a descriptive name to this status input. |
| Control Mode | Normal, Demand Sync | This field displays how the status input functions. <ul style="list-style-type: none"> • Normal: the status input is not associated with another meter function. The meter counts and records the number of incoming pulses normally. • Demand Sync: the status input is associated with one of the input sync demand functions. The meter uses the incoming pulse to synchronize its demand period with the external source. |
| Debounce | 0 to 9999 | Debounce is the time delay that compensates for mechanical contact bounce. Use this field to set how long (in milliseconds) the external signal must remain in a certain state to be considered a valid state change. |
| Associations | — | This field displays additional information if the status input is already associated with another meter function. |

Digital output applications

The meter is equipped with two digital output ports (D1, D2). You can configure the digital outputs for use in the following applications:

Switching applications, for example, to provide on/off control signals for switching capacitor banks, generators, and other external devices and equipment.

Energy pulsing applications, where a receiving device determines energy usage by counting the kWh pulses coming from the meter’s digital output port.

Unary, digital and standard alarm configurations.

Wiring the digital output

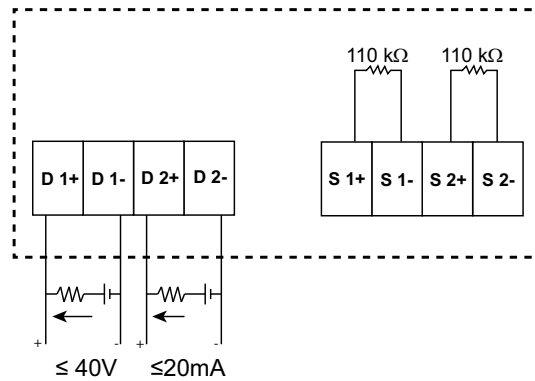

Default digital output state

The default digital output state for I/O pin is high (switch closed). The digital output state for I/O pin can be changed through communication.

| I/O pin state | External mode | Alarm | Display | Comm | Switch |
|---------------|---------------|-------|---------|------|--------|
| Low | 0 | 0 | OFF | 0 | Open |
| | 0 | 1 | ON | 1 | Closed |
| | 0 | 0 | OFF | 0 | Open |
| | 1 | 0 | ON | 1 | Closed |
| High | 0 | 0 | OFF | 0 | Closed |
| | 0 | 1 | ON | 1 | Open |
| | 0 | 0 | OFF | 0 | Closed |
| | 1 | 0 | ON | 1 | Open |

Demand parameter for digital output

The associating demand parameters (Present demand (VA, W, VAR), Last demand (VA, W, VAR) and Predict demand (VA, W, VAR)) can be configured for digital output based on alarm events when exceeds the set upper limit. Only one demand parameter can be set at a given time.

NOTE: The alarm set up is done through communication using ION setup.

Configuring digital outputs using ION Setup

You can use ION Setup to configure the digital outputs (D1 and D2).

1. Start ION Setup.
2. Connect to your meter.

3. Navigate to **I/O configuration > I/O Setup**.
4. Select a digital output to configure and click **Edit**.
The setup screen for that digital output is displayed.
5. Enter a descriptive name for the digital output in the **Label** field.
6. Configure the other setup parameters as required.
7. Click **Send** to save your changes.

Digital output setup parameters available using ION Setup

| Parameter | Values | Description |
|---------------|--------------------------|--|
| Label | — | Use this field to change the default label and assign a descriptive name to this digital output. |
| Control Mode | External, Alarm, Energy | This field displays how the digital output functions. <ul style="list-style-type: none"> • External: the digital output is controlled remotely either through software or by a PLC using commands sent through communications. • Alarm: the digital input is associated with the alarm system. The meter sends a pulse to the digital output port when the alarm is triggered. • Energy: The digital output is associated with energy pulsing. When this mode is selected, you can select the energy parameter and the set the pulse rate (pulses/kW). |
| Behavior Mode | Normal, Timed, Coil Hold | <ul style="list-style-type: none"> • Normal: this mode applies when control mode is set to External or Alarm. In the event of trigger for External mode, the digital output remains in the ON state until an OFF command is sent by the computer or PLC. In the event of trigger for Alarm mode, the digital output remains in the ON state until the drop out point is crossed. • Timed: the digital output remains ON for the period defined by the On Time setup register. • Coil Hold: this mode applies when control mode is set to External or Alarm. For a unary alarm that is associated with a digital output, you must set Behavior Mode to Coil Hold. The output turns on when the “energize” command is received and turns off when the “coil hold release” command is received. In the event of a control power loss, the output remembers and returns to the state it was in when control power was lost. |
| On Time (s) | 0 to 9999 | This setting defines the pulse width (ON time) in seconds. NOTE: In energy mode, the digital output pulse ON time is fixed for 20 ms. |
| Select Alarms | All available alarms | Applies when Control Mode is set to Alarm. Select one or more alarms to monitor. |
| Associations | — | This field displays additional information if the digital output is already associated with another meter function. |

Relay output applications

Relay outputs can be configured to be used in switching applications, for example, to provide on/off control signals for switching capacitor banks, generators, and other external devices and equipment.

Wiring the two digital inputs and relay output

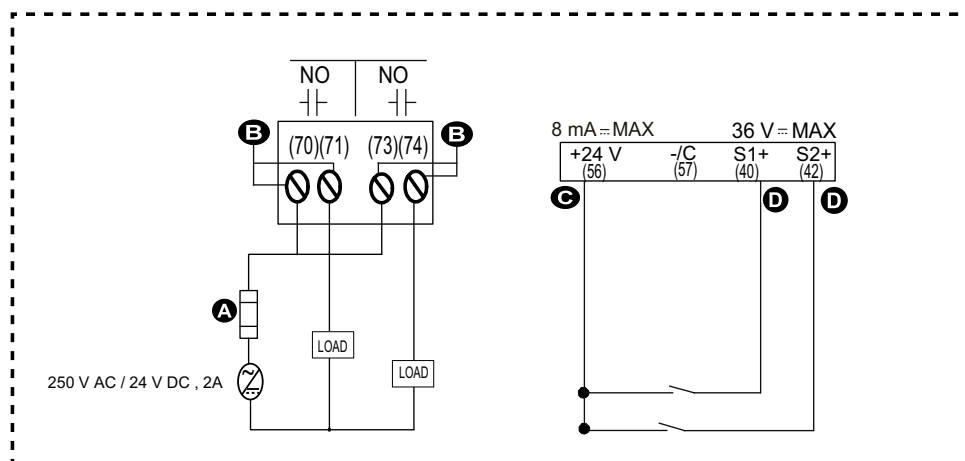

| | |
|---|-----------------------------------|
| A | Overcurrent protective device |
| B | Relay 1 (70,71) , Relay 2 (73,74) |
| C | Whetting output |
| D | Digital status inputs |

Configuring relay outputs using ION Setup

You can use ION Setup to configure the relay output ports (Relay 1 and Relay 2).

1. Start ION Setup.
2. Connect to your meter.
3. Navigate to **I/O configuration > I/O Setup**.
4. Select a relay output to configure and click **Edit**.
The setup screen for that relay output is displayed.
5. Enter a descriptive name for the relay output's **Label**.
6. Configure the other setup parameters as required.

7. Click **Send** to save your changes.

Relay output setup parameters available through the ION Setup

| Parameter | Values | Description |
|---------------|--------------------------|---|
| Label | — | Use this field to change the default label and assign a descriptive name to this relay output. |
| Control Mode | External, Alarm | This field displays how the relay output functions. <ul style="list-style-type: none"> External: the relay output is controlled remotely either through software or by a PLC using commands sent through communications. Alarm: the relay output is associated with the alarm system. The meter sends a pulse to the relay output port when the alarm is triggered. |
| Behavior Mode | Normal, Timed, Coil Hold | <ul style="list-style-type: none"> Normal: this mode applies when control mode is set to External or Alarm. In the event of trigger for External mode, the relay output remains in the closed state until an open command is sent by the computer or PLC. In the event of trigger for Alarm mode, the relay output remains in the closed state until the drop out point is crossed. Timed: the relay output remains ON for the period defined by the On Time setup register. Coil Hold: this mode applies when control mode is set to External or Alarm. For a unary alarm that is associated with a relay output, you must set Behavior Mode to Coil Hold. The output turns on when the “energize” command is received and turns off when the “coil hold release” command is received. In the event of a control power loss, the output remembers and returns to the state it was in when control power was lost. |
| On Time (s) | 0 to 9999 | This setting defines the pulse width (ON time) in seconds. |
| Select Alarms | All available alarms | Applies when Control Mode is set to Alarm. Select one or more alarms to monitor. |
| Associations | — | This field displays additional information if the relay output is already associated with another meter function. |

IO LED Indicator

The IO LED indicator alerts or informs you of meters’ IO activities. The LED blinks at a constant pace when the IO module is attached to the meter.

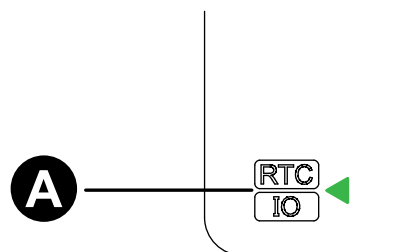

| | |
|---|--------------------------|
| A | IO LED indicator (Green) |
|---|--------------------------|

Alarms

Alarms overview

An alarm is the meter's means of notifying you when an alarm condition is detected, such as an error or an event that falls outside of normal operating conditions.

Alarms are typically setpoint-driven and can be programmed to monitor certain behaviors, events or unwanted conditions in your electrical system.

You can configure your meter to generate and display high, medium and low priority alarms when predefined events are detected in the meter's measured values or operating states. Your meter also logs the alarm event information.

The meter ships with some alarms already enabled from the factory. Other alarms need to be configured before the meter can generate alarms.

Customize meter alarms as required, such as changing the priority. You can also create custom alarms using the advanced features of your meter.

Alarm types

Your meters supports a number of different alarm types.

| Type | Number |
|----------|--------|
| Unary | 4 |
| Digital | 2 |
| Standard | 23 |

Unary alarms

A unary alarm is the simplest type of alarm — it monitors a single behavior, event or condition.

Available unary alarms

Your meter has a set of 4 unary alarms.

| Alarm label | Description |
|------------------|---|
| Meter Powerup | Meter powers on after losing control power. |
| Meter Reset | Meter resets for any reason. |
| Meter Diagnostic | Meter's self-diagnostic feature detects a problem. |
| Phase Reversal | Meter detects a phase rotation different than expected. |

Digital alarms

Digital alarms monitor the ON or OFF state of the meter's digital / status inputs.

Digital alarm with setpoint delay

To prevent false triggers from erratic signals, you can set up pickup and dropout time delays for the digital alarm.

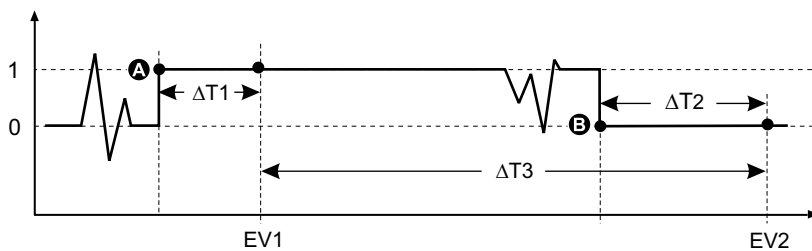

| | | | |
|-----|--------------------------------|-----|---------------------------------|
| A | Pickup setpoint (1 = ON) | ΔT2 | Dropout time delay (in seconds) |
| B | Dropout setpoint (0 = OFF) | EV2 | End of alarm condition |
| ΔT1 | Pickup time delay (in seconds) | ΔT3 | Alarm duration (in seconds) |
| EV1 | Start of alarm condition | | |

NOTE: To prevent filling the alarm log with nuisance alarm trips, the digital alarm is automatically disabled if the digital / status input changes state more than 4 times in one second or more than 10 times in ten seconds. In this case, you must re-enable the alarm using the display or ION Setup.

Available digital alarms

Your meter has a set of 2 digital alarms.

| Alarm label | Description |
|------------------|-----------------|
| Digital Alarm S1 | Digital input 1 |
| Digital Alarm S2 | Digital input 2 |

Standard alarms

Standard alarms are setpoint-driven alarms which monitor certain behaviors, events or unwanted conditions in your electrical system.

Standard alarms have a detection rate equal to the 50/60 meter cycle, which is nominally 1 second if the meter’s frequency setting is configured to match the system frequency (50 or 60 Hz).

Many of the standard alarms are three-phase alarms. Alarm setpoints are evaluated for each of the three phases individually, but the alarm is reported as a single alarm. The alarm pickup occurs when the first phase exceeds the alarm pickup magnitude for the pickup time delay. The alarm is active as long as any phase remains in an alarm state. The alarm dropout occurs when the last phase drops below the dropout magnitude for the dropout time delay.

Example of over and under setpoint (standard) alarm operation

The meter supports over and under setpoint conditions on standard alarms.

A setpoint condition occurs when the magnitude of the signal being monitored crosses the limit specified by the pickup setpoint setting and stays within that limit for a minimum time period specified by the pickup time delay setting.

The setpoint condition ends when the magnitude of the signal being monitored crosses the limit specified by dropout setpoint setting and stays within that limit for a minimum time period specified by dropout time delay setting.

Over setpoint

When the value rises above the pickup setpoint setting and remains there long enough to satisfy the pickup time delay period (ΔT1), the alarm condition is set to

ON. When the value falls below the dropout setpoint setting and remains there long enough to satisfy the dropout time delay period ($\Delta T2$), the alarm condition is set to OFF.

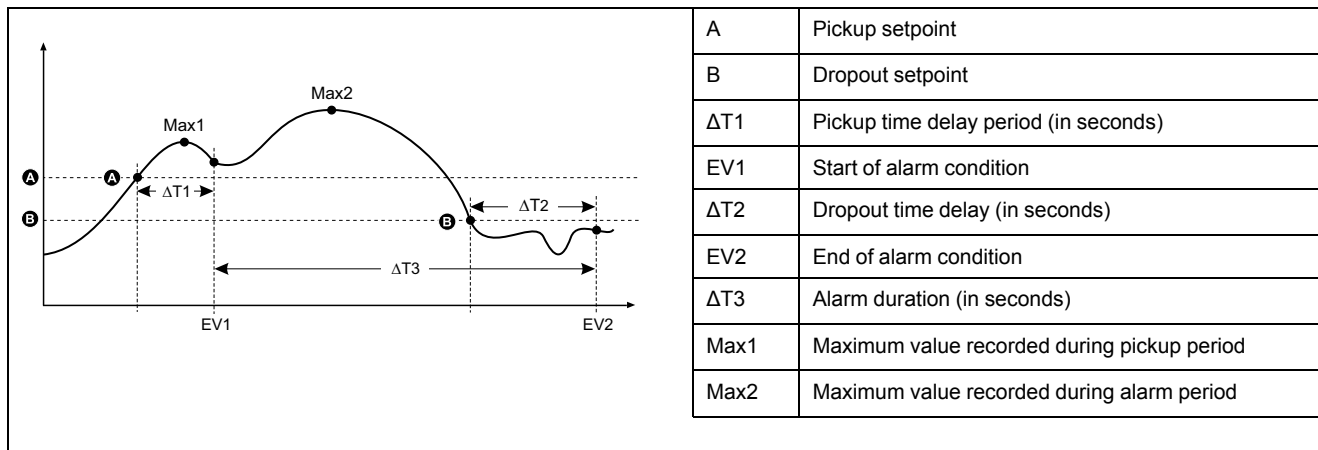

The meter records the date and time when the alarm event starts (EV1) and when it ends (EV2). The meter also performs any task assigned to the event, such as operating a digital output. The meter also records maximum values (Max1, Max2) before, during or after the alarm period.

Under setpoint

When the value falls below the pickup setpoint setting and remains there long enough to satisfy the pickup time delay period ($\Delta T1$), the alarm condition is set to ON. When the value rises above the dropout setpoint setting and remains there long enough to satisfy the dropout time delay period ($\Delta T2$), the alarm condition is set to OFF.

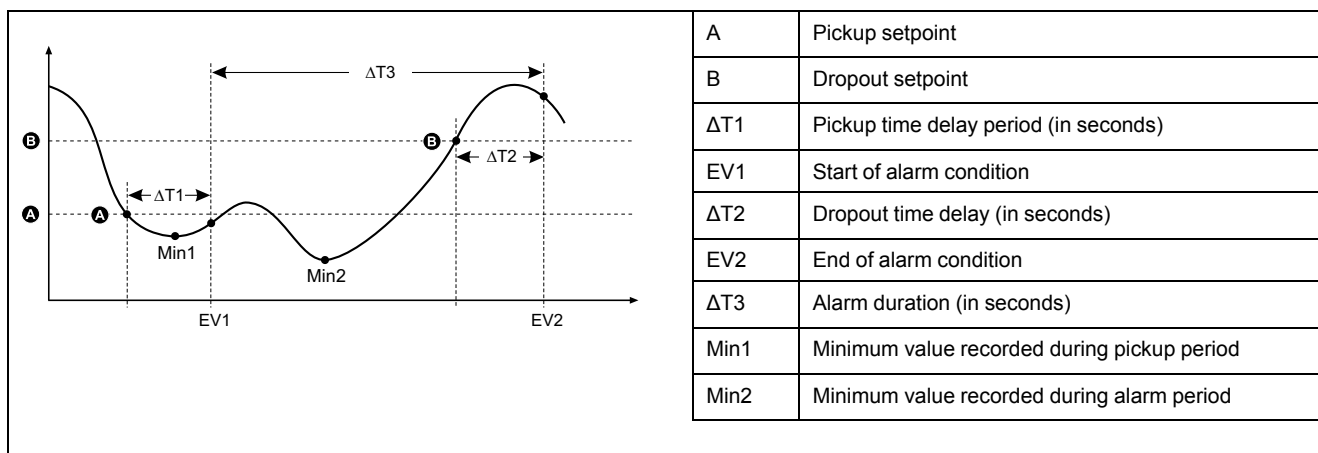

The meter records the date and time when the alarm event starts (EV1) and when it ends (EV2). The meter also performs any task assigned to the event, such as operating a digital output. The meter also records minimum values (Min1, Min2) before, during or after the alarm period.

Maximum allowable setpoint

The meter is programmed to help prevent user data entry errors, with set limits for the standard alarms.

The maximum setpoint value you can enter for some of the standard alarms depends on the voltage transformer ratio (VT ratio), current transformer ratio (CT ratio), system type (i.e., number of phases) and/or the maximum voltage and maximum current limits programmed at the factory.

NOTE: VT ratio is the VT primary divided by the VT secondary and CT ratio is the CT primary divided by the CT secondary.

| Standard alarm | Maximum setpoint value |
|--------------------------------------|--|
| Over Phase Current | (maximum current) x (CT ratio) |
| Under Phase Current | (maximum current) x (CT ratio) |
| Under Voltage L-L | (maximum voltage) x (VT ratio) |
| Over Voltage L-N | (maximum voltage) x (VT ratio) |
| Under Voltage L-N | (maximum voltage) x (VT ratio) |
| Over Active Power | (maximum voltage) x (maximum current) x (number of phases) |
| Over Reactive Power | (maximum voltage) x (maximum current) x (number of phases) |
| Over Apparent Power | (maximum voltage) x (maximum current) x (number of phases) |
| Over Present Active Power Demand | (maximum voltage) x (maximum current) x (number of phases) |
| Over Last Active Power Demand | (maximum voltage) x (maximum current) x (number of phases) |
| Over Predicted Active Power Demand | (maximum voltage) x (maximum current) x (number of phases) |
| Over Present Reactive Power Demand | (maximum voltage) x (maximum current) x (number of phases) |
| Over Last Reactive Power Demand | (maximum voltage) x (maximum current) x (number of phases) |
| Over Predicted Reactive Power Demand | (maximum voltage) x (maximum current) x (number of phases) |
| Over Present Apparent Power Demand | (maximum voltage) x (maximum current) x (number of phases) |
| Over Last Apparent Power Demand | (maximum voltage) x (maximum current) x (number of phases) |
| Over Predicted Apparent Power Demand | (maximum voltage) x (maximum current) x (number of phases) |

Available standard alarms

Your meter has a set of standard alarms.

NOTE: Some alarms do not apply to all power system configurations. For example, line-to-neutral voltage alarms cannot be enabled on 3-phase delta systems. Some alarms use the system type and the VT or CT ratio to determine the maximum allowed setpoint.

| Alarm label | | Valid range and resolution | | Units |
|----------------------------------|--------------------|---------------------------------|--------------|-------|
| ION Setup | Display | ION Setup | Display | |
| Over Phase Current | Over Current, Ph | 0.000 to 99999.000 | 0 to 99999 | A |
| Under Phase Current | Under Current, Ph | 0.000 to 99999.000 | 0 to 99999 | A |
| Over Voltage L-L | Over Voltage, L-L | 0.00 to 999999.00 | 0 to 999999 | V |
| Under Voltage L-L | Under Voltage, L-L | 0.00 to 999999.00 | 0 to 9999999 | V |
| Over Voltage L-N | Over Voltage, L-N | 0.00 to 999999.00 | 0 to 9999999 | V |
| Under Voltage L-N | Under Voltage L-N | 0.00 to 999999.00 | 0 to 9999999 | V |
| Over Active Power | Over kW | 0.0 to 9999999.0 | 0 to 9999999 | kW |
| Over Reactive Power | Over kVAR | 0.0 to 9999999.0 | 0 to 9999999 | kVAR |
| Over Apparent Power | Over kVA | 0.0 to 9999999.0 | 0 to 9999999 | kVA |
| Leading True PF | Lead PF, True | -1.00 to -0.01 and 0.01 to 1.00 | | — |
| Lagging True PF | Lag PF, True | -1.00 to -0.01 and 0.01 to 1.00 | | — |
| Over Frequency | Over Frequency | 0.000 to 99.000 | | Hz |
| Under Frequency | Under Frequency | 0.000 to 99.000 | | Hz |
| Over Voltage THD | Over Voltage THD | 0.000 to 99 | | % |
| Over Present Active Power Demand | Over kW Dmd, Pres | 0.0 to 9999999.0 | 0 to 9999999 | kW |
| Over Last Active Power Demand | Over kW Dmd, Last | 0.0 to 9999999.0 | 0 to 9999999 | kW |

| Alarm label | | Valid range and resolution | | Units |
|--------------------------------------|---------------------|----------------------------|--------------|-------|
| ION Setup | Display | ION Setup | Display | |
| Over Predicted Active Power Demand | Over kW Dmd, Pred | 0.0 to 9999999.0 | 0 to 9999999 | kW |
| Over Present Reactive Power Demand | Over kVAR Dmd, Pres | 0.0 to 9999999.0 | 0 to 9999999 | kVAR |
| Over Last Reactive Power Demand | Over kVAR Dmd, Last | 0.0 to 9999999.0 | 0 to 9999999 | kVAR |
| Over Predicted Reactive Power Demand | Over kVAR Dmd, Pred | 0.0 to 9999999.0 | 0 to 9999999 | kVAR |
| Over Present Apparent Power Demand | Over kVA Dmd, Pres | 0.0 to 9999999.0 | 0 to 9999999 | kVA |
| Over Last Apparent Power Demand | Over kVA Dmd, Last | 0.0 to 9999999.0 | 0 to 9999999 | kVA |
| Over Predicted Apparent Power Demand | Over kVA Dmd, Pred | 0.0 to 9999999.0 | 0 to 9999999 | kVA |

Power factor (PF) alarms

You can set up a Leading PF or Lagging PF alarm to monitor when the circuit's power factor goes above or below the threshold you specify.

The Leading PF and Lagging PF alarms use the power factor quadrants as the values on the y-axis, with quadrant II on the lowest end of the scale, followed by quadrant III, quadrant I, and finally quadrant IV on the highest end of the scale.

| Quadrant | PF values | Lead/Lag |
|----------|-----------|----------------------|
| II | 0 to -1 | Leading (capacitive) |
| III | -1 to 0 | Lagging (inductive) |
| I | 0 to 1 | Lagging (inductive) |
| IV | 1 to 0 | Leading (capacitive) |

Leading PF alarm

The Leading PF alarm monitors an over setpoint condition.

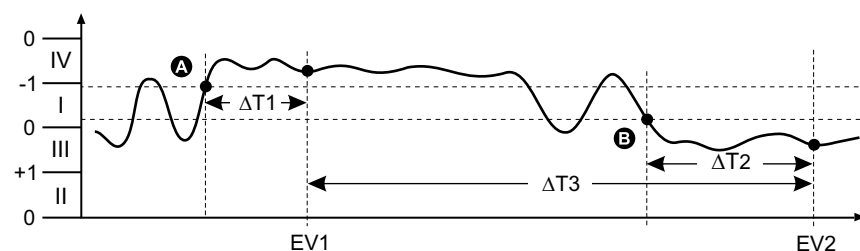

| | | | |
|-------------|----------------------------------|-------------|---------------------------------|
| A | Pickup setpoint | $\Delta T2$ | Dropout time delay (in seconds) |
| B | Dropout setpoint | EV2 | End of alarm condition |
| $\Delta T1$ | Pickup delay period (in seconds) | $\Delta T3$ | Alarm duration (in seconds) |
| EV1 | Start of alarm condition | | |

Lagging PF alarm

The Lagging PF alarm monitors an under setpoint condition.

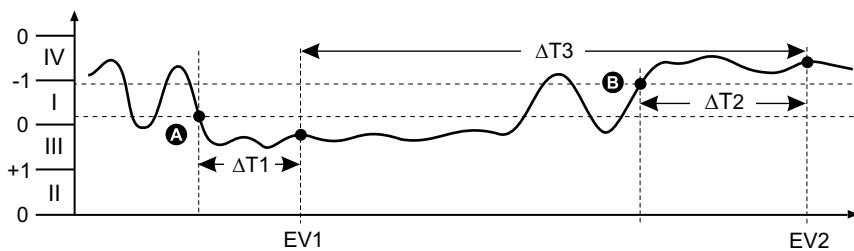

| | | | |
|-----|----------------------------------|-----|---------------------------------|
| A | Pickup setpoint | ΔT2 | Dropout time delay (in seconds) |
| B | Dropout setpoint | EV2 | End of alarm condition |
| ΔT1 | Pickup delay period (in seconds) | ΔT3 | Alarm duration (in seconds) |
| EV1 | Start of alarm condition | | |

Alarm priorities

Each alarm has a priority level that you can use to distinguish between events that require immediate action and those that do not require action.

| Alarm priority | Alarm display notification and recording method | | | |
|----------------|---|--|---|-----------------------------|
| | Alarm LED | Alarm icon | Alarm details | Alarm logging |
| High | Blinks while the alarm is active. | Blinks while the alarm is active. Alarm icon remains displayed until acknowledged. | Click Details to display what caused the alarm to pickup or drop off. Click Ack to acknowledge the alarm. | Recorded in alarm log. |
| Medium | Blinks while the alarm is active. | Blinks while the alarm is active. | Click Details to display what caused the alarm to pickup or drop off. | Recorded in alarm log. |
| Low | Blinks while the alarm is active. | Blinks while the alarm is active. | Click Details to display what caused the alarm to pickup or drop off. | Recorded in alarm log. |
| None | No activity | None | None | Recorded in event log only. |

NOTE: The alarm LED notification only occurs if the alarm / energy pulsing LED is configured for alarming.

Multiple alarm considerations

If multiple alarms with different priorities are active at the same time, the display shows the alarms in the order they occurred.

Alarm setup overview

You can use ION Setup to configure unary, digital or standard (1-Sec) alarms.

If you make changes to the basic meter setup, all alarms are disabled to prevent undesired alarm operation.

| |
|---|
| NOTICE |
| <p>UNINTENDED EQUIPMENT OPERATION</p> <ul style="list-style-type: none"> • Verify all alarm settings are correct and make adjustments as necessary. • Re-enable all configured alarms. <p>Failure to follow these instructions can result in incorrect alarm functions.</p> |

Built-in error-checking

ION Setup dynamically checks incorrect setup combinations. When you enable an alarm, you must set up the pickup and dropout limits to acceptable values first in order to exit the setup screen.

Setting up alarms using ION Setup

You can use ION Setup to create and set up alarms.

1. Start ION Setup and connect to your meter.
2. Open the **Alarming** screen.
3. Select the alarm you want to configure and click **Edit**.
4. Configure the setup parameters as explained in the different alarm setup sections.

See the ION Setup Device Configuration guide for more information.

Unary alarm setup parameters

Configure the unary alarm setup parameters as required.

ION Setup controls are shown in parentheses.

| Setting | Option or range | Description |
|-----------------------------|--|--|
| Enable | Yes (checked) or No (cleared) | This enables or disables the alarm. |
| Priority | High, Medium, Low, None | This sets the alarm priority and notification options. |
| Select Dig Output (Outputs) | None Digital Output D1 Digital Output D2 Digital Output D1 & D2 | Select the digital output(s) you want to control when the alarm is triggered. |
| Behaviour | Normal Timed Coil Hold | Select the required behaviour mode NOTE: When you select Normal value, Digital Output is not triggered |

Digital alarm setup parameters

Configure the digital alarm setup parameters as required.

ION Setup controls are shown in parentheses.

| Setting | Option or range | Description |
|-----------------------------------|-------------------------------|---|
| Enable | Yes (checked) or No (cleared) | This enables or disables the alarm. |
| Priority | High, Medium, Low, None | This sets the alarm priority and notification options. |
| Pickup Setpoint (Setpoint Pickup) | On, Off | Use this setting to control when to trip the alarm, based on the state of the digital input (On or Off). |
| Pickup Time Delay (Delay) | 0 to 999999 | This specifies the number of seconds the digital input must be in the alarm pickup state before the alarm is tripped. |

| Setting | Option or range | Description |
|---|--|--|
| Dropout Time Delay (Setpoint Dropout Delay) | 0 to 999999 | This specifies the number of seconds the digital input must be out of the alarm pickup state before the alarm turns off. |
| Select Dig Output (Outputs) | None Digital Output D1 Digital Output D2 Digital Output D1 & D2 | Select the digital output(s) you want to control when the alarm is triggered. |

Standard (1-Sec) alarm setup parameters

Configure the standard alarm setup parameters as required.

ION Setup controls are shown in parentheses.

NOTE: It is recommended that you use ION Setup to configure standard (1-Sec) alarms. ION Setup supports a higher resolution to allow you to specify more decimal places when setting up the pickup setpoint and dropout setpoint values for certain measurements.

| Setting | Option or range | Description |
|-------------------------------------|--|--|
| Enable | Yes (checked) or No (cleared) | This enables or disables the alarm. |
| Priority | High, Medium, Low, None | This sets the alarm priority and notification options. |
| Pickup Setpoint mA (Pickup Limit) | Varies depending on the standard alarm you are setting up | This is the value (magnitude) you define as the setpoint limit for triggering the alarm. For "over" conditions, this means the value has gone above the Pickup limit. For "under" conditions, this means the value has gone below the Pickup limit. |
| Pickup Time Delay (Delay) | 0 to 999999 | This specifies the number of seconds the signal must stay above the pickup setpoint (for "over" conditions), or below the pickup setpoint (for "under" conditions) before the alarm is tripped. |
| Dropout Setpoint mA (Dropout Limit) | Varies depending on the standard alarm you are setting up | This is the value (magnitude) you define as the limit for dropping out of the alarm condition. For "over" conditions, this means the value has gone below the Dropout limit. For "under" conditions, this means the value has gone above the Pickup limit. |
| Dropout Time Delay (Delay) | 0 to 999999 | This specifies the number of seconds the signal must stay below the dropout setpoint (for "over" conditions), or above the dropout setpoint (for "under" conditions) before the alarm condition is ended. |
| PU Set Point Lead/Lag (Lead, Lag) | Lead or Lag | Applies to PF (power factor) alarms only. Use this to set the PF value and quadrant to set the pickup setpoint for an over PF condition (PF Leading) or under PF condition (PF Lagging). |
| DO Set Point Lead/Lag (Lead, Lag) | Lead or Lag | Applies to PF (power factor) alarms only. Use this to set the PF value and quadrant to set the dropout setpoint for an over PF condition (PF Leading) or under PF condition (PF Lagging). |
| Select Dig Output (Outputs) | None Digital Output D1 Digital Output D2 Digital Output D1 & D2 | Select the digital output(s) you want to control when the alarm is triggered. |

LED alarm indicator

You can use the meter's alarm / energy pulsing LED as an alarm indicator.

When set to detect alarms, the LED blinks to indicate an alarm condition.

Configuring the LED for alarms using the display

You can use the meter display to configure the alarm / energy pulsing LED for alarming.

1. Navigate to the **Maint > Setup > LED**.
2. Set the mode to **Alarm**, then press **OK**.
3. Press the up arrow to exit. Press **Yes** to save your changes.

Configuring the LED for alarms using ION Setup

You can use the ION Setup to configure your meter's LED for alarming.

1. Open ION Setup and connect to your meter. See the ION Setup Help for instructions.
2. Navigate to **Energy Pulsing**.
3. Select **Front Panel LED** and click **Edit**.
4. Set the control mode to **Alarm** and click **OK**.
5. Click **Send** to save your changes.

Alarm display and notification

The meter notifies you when an alarm condition is detected.

Alarm icon

When a low, medium or high priority alarm is tripped, this symbol appears at the top right corner of the display screen, indicating that an alarm is active:



For high priority alarms, the alarm icon remains displayed until you acknowledge the alarm.

Alarm / energy pulsing LED

If configured for alarming, the alarm / energy pulsing LED also flashes to indicate the meter has detected an alarm condition.

Alarm screens

If your meter is equipped with a display, you can use the buttons to navigate to the alarm setup or display screens.

Active alarms

When a pickup event occurs, the active alarm list appears on the meter display's Active Alarms screen. Press **Detail** to see more event information.

Alarm details

Details about the alarms can be viewed using:

- the active alarms (Active), alarm history (Hist), alarm counters (Count) and unacknowledged alarms (Unack) screens on the meter display, or

Active alarms list and alarm history log

Each occurrence of a low, medium or high priority alarm is stored in the active alarms list and recorded in the alarm history log.

The active alarm list holds 40 entries at a time. The list works as a circular buffer, replacing old entries as new entries over 40 are entered into the active alarms list. The information in the active alarms list is volatile and reinitializes when the meter resets.

The alarm history log holds 40 entries. The log also works as a circular buffer, replacing old entries with new entries. The information in the alarm history log is nonvolatile and is retained when the meter resets.

Viewing active alarm details using the display

When an alarm condition becomes true (alarm = ON), the alarm is displayed on the active alarms screen.

Alarms are displayed sequentially in the order of their occurrence, regardless of priority. The alarm details show the date and time of the alarm event, the type of event (for example, pickup or unary), which phase the alarm condition was detected on, and the value that caused the alarm condition.

NOTE: Alarm details are not available if the alarm priority is set to None.

The alarm details (for low, medium and high priority alarms) are also recorded in the alarm history log.

1. Navigate to **Alarm > Active**.
2. Select the alarm you want to view (the latest ones appear on top).
3. Press **Detail**.

NOTE: For unacknowledged high priority alarms, the Ack option appears on this screen. Press **Ack** to acknowledge the alarm, or return to the previous screen if you do not want to acknowledge the alarm.

Viewing alarm history details using the display

The alarm history log keeps a record of active alarms and past alarms.

When an active alarm condition becomes false (alarm = OFF), the event is recorded in the alarm history log and alarm notification (alarm icon, alarm LED) is turned off.

Alarms are displayed sequentially in the order of their occurrence, regardless of priority. The alarm details show the date and time of the alarm event, the type of event (for example, dropout or unary), which phase the alarm condition was detected on, and the value that caused the alarm condition to turn ON or OFF.

NOTE: Alarm details are not available if the alarm priority is set to None.

1. Navigate to **Alarm > Hist**.
2. Select the alarm you want to view (the latest ones appear on top).
3. Press **Detail**.

NOTE: For unacknowledged high priority alarms, the **Ack** option appears on this screen. Press **Ack** to acknowledge the alarm, or return to the previous screen if you do not want to acknowledge the alarm.

Alarms counters

Every occurrence of each type of alarm is counted and recorded in the meter.

Alarms rollover value

The alarm counters roll over to zero after reaching the value 9999.

Resetting alarms using ION Setup

Use ION Setup to reset alarms.

You can also reset alarms using the meter display.

1. Connect to your meter in ION Setup.
2. Open the **Meter Resets** screen.
3. Select the alarm parameters to clear and click **Reset**.

Meter logging

Logs overview

This chapter briefly describes the following logs of the meter:

- Alarm log
- User-defined data log

Logs are files stored in the non-volatile memory of the meter and are referred to as “on-board logs”.

Setting up the data log

You can select 2 items to record in the data log and the frequency (logging interval) that you want those values updated.

Use ION Setup to configure data logging.

NOTICE

DATA LOSS

Save the contents of the data log before configuring it.

Failure to follow these instructions can result in data loss.

1. Start ION Setup and open your meter in setup screens mode (**View > Setup Screens**). See the ION Setup Help for instructions.
2. Double-click **Data Log #1**.
3. Set up the logging frequency and measurements/data to log.
4. Click **Send** to save the changes to the meter.

| Parameter | Values | Description |
|-----------|---|---|
| Status | Enable, Disable | Set this parameter to enable or disable data logging in the meter. |
| Interval | 15 minutes, 30 minutes, 60 minutes | Select a time value to set the logging frequency. |
| Channels | Items available for logging can vary based on the meter type. | Select an item to record from the “Available” column, then click the double-right arrow button to move the item to the “Selected” column. To remove an item, select it from the “Selected” column then click the double-left arrow button. |

Saving the data log contents using ION Setup

You can use ION Setup to save the contents of the data log.

1. Start ION Setup and open your meter in data screens mode (**View > Data Screens**). See the ION Setup help for instructions.
2. Double-click **Data Log #1** to retrieve the records.

3. Once the records have finished uploading, right-click anywhere in the viewer and select **Export CSV** from the popup menu to export the entire log.
NOTE: To export only selected records in the log, click the first record you want to export, hold down the SHIFT key and click the last record you want to export, then select **Export CSV** from the popup menu.
4. Navigate to the folder where you want to save the data log file, then click **Save**.

Alarm log

Alarm records are stored in the meter's alarm history log.

By default, the meter can log the occurrence of any alarm condition. Each time an alarm occurs it is entered into the alarm log. The alarm log in the meter stores the pickup and dropout points of alarms along with the date and time associated with these alarms. You can view and save the alarm log to disk, and reset the alarm log to clear the data out of the meter's memory.

The meter stores alarm log data in non-volatile memory. The size of the alarm log is fixed at 40 records.

Measurements and calculations

Meter initialization

Meter Initialization is a special command that clears the meter's energy, power, demand values, and meter operation timer.

It is common practice to initialize the meter after its configuration is completed, before adding it to an energy management system.

After configuring all the meter setup parameters, navigate through the different meter display screens and make sure the displayed data is valid then perform meter initialization.

NOTE: You can perform meter initialization using ION setup and secured command interface.

Real-time readings

The meter measures currents and voltages, and reports in real time the RMS (Root Mean Squared) values for all three phases and neutral.

The voltage and current inputs are continuously monitored at a sampling rate of 64 samples per cycle. This amount of resolution helps enable the meter to provide reliable measurements and calculated electrical values for various commercial, buildings and industrial applications.

Energy measurements

The meter provides fully bi-directional, 4-quadrant energy metering.

The meter stores all accumulated active, reactive and apparent energy measurements in nonvolatile memory:

- kWh, kVARh, kVAh (delivered and received)
- kWh, kVARh, kVAh net (delivered - received)
- kWh, kVARh, kVAh absolute (delivered + received)

All energy parameters represent the total for all three phases.

NOTE: Based on the energy scale selection, when any of energy parameters overflow at 999.99 all energy parameters value resets.

Quadrant based VARh

NOTE: Applicable only for PM2220/PM2230 meter models

Quadrant based reactive energy values are available only on communication. These are not available on meter display. These reactive energies are for Q1 , Q2, Q3 and Q4 quadrants.

On communication quadrant based reactive energies will be recorded as follows:

- Q1 (00 to 90 Degree) = Q1 VARh , Del
- Q2 (90 to 180 Degree) = Q2 VARh , Del
- Q3 (180 to 270 degree) = Q3 VARh, Rec
- Q4 (270 to 360 degree) = Q4 VARh , Rec

If energy is cleared, all quadrant based VARhs will be cleared.

Min/max values

When the readings reach their lowest or highest value, the meter updates and saves these min/max (minimum and maximum) quantities in non-volatile memory.

The meter's real-time readings are updated once every 50 cycles for 50 Hz systems, or once every 60 cycles for 60 Hz systems.

Power demand

Power demand is a measure of average power consumption over a fixed time interval.

NOTE: If not specified, references to demand are assumed to mean power demand.

The meter measures instantaneous consumption and can calculate demand using various methods.

Power demand calculation methods

Power demand is calculated by dividing the energy accumulated during a specified period by the length of that period.

How the meter performs this calculation depends on the method and time parameters you select (for example, timed rolling block demand with a 15-minute interval and 5-minute subinterval).

To be compatible with electric utility billing practices, the meter provides the following types of power demand calculations:

- Block interval demand
- Synchronized demand
- Thermal demand

You can configure the power demand calculation method from the display or software.

Block interval demand

For block interval demand method types, you specify a period of time interval (or block) that the meter uses for the demand calculation.

Select/configure how the meter handles that interval from one of these different methods:

| Type | Description |
|---------------------|---|
| Timed Sliding Block | Select an interval from 1 to 60 minutes (in 1-minute increments). If the interval is between 1 and 15 minutes, the demand calculation <i>updates every 15 seconds</i> . If the interval is between 16 and 60 minutes, the demand calculation <i>updates every 60 seconds</i> . The meter displays the demand value for the last completed interval. |
| Timed Block | Select an interval from 1 to 60 minutes (in 1-minute increments). The meter calculates and updates the demand at the end of each interval. |
| Timed Rolling Block | Select an interval and a subinterval. The subinterval must divide evenly into the interval (for example, three 5-minute subintervals for a 15-minute interval). Demand is <i>updated at the end of each subinterval</i> . The meter displays the demand value for the last completed interval. |

Block interval demand example

The following illustration shows the different ways power demand is calculated using the block interval method. In this example, the interval is set to 15 minutes.

Timed Sliding Block

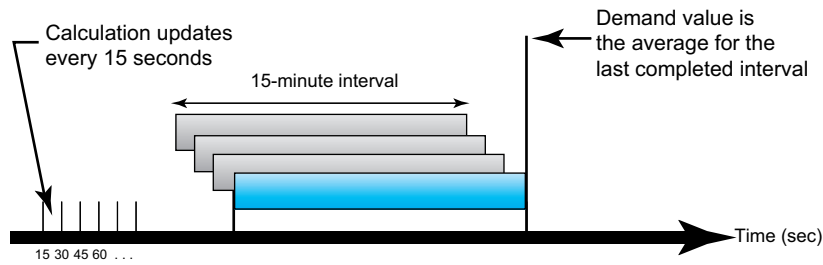

Timed Block

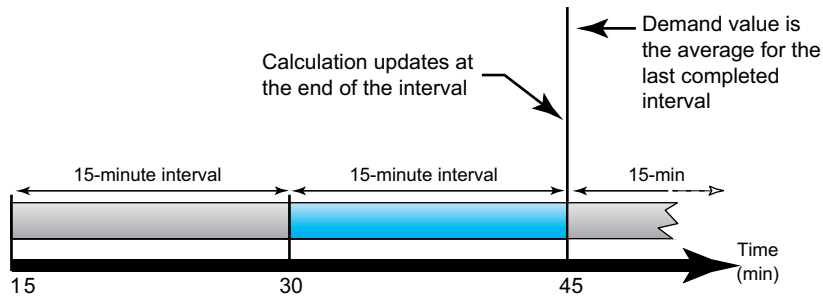

Timed Rolling Block

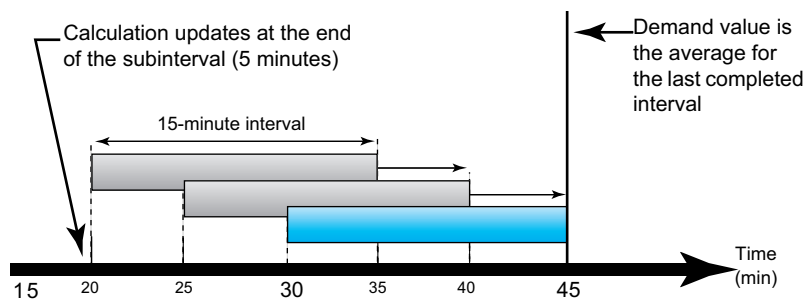

Synchronized demand

You can configure the demand calculations to be synchronized using an external pulse input, a command sent over communications, or the device's internal real-time clock.

| Type | Description |
|-----------------------------|--|
| Command synchronized demand | This method allows you to synchronize the demand intervals of multiple meters on a communications network. For example, if a programmable logic controller (PLC) input is monitoring a pulse at the end of a demand interval on a utility revenue meter, you can program the PLC to issue a command to multiple meters whenever the utility meter starts a new demand interval. Each time the command is issued, the demand readings of each meter are calculated for the same interval. |
| Clock synchronized demand | This method allows you to synchronize the demand interval to the meter's internal real-time clock. This helps you synchronize the demand to a particular time, typically on the hour (for example, at 12:00 am). If you select another time of day when the demand intervals are to be synchronized, the time must be specified in minutes from midnight. For example, to synchronize at 8:00 am, select 480 minutes. |

NOTE: For these demand types, you can choose block or rolling block options. If you select a rolling block demand option, you need to specify a subinterval.

Thermal demand

Thermal demand calculates the demand based on a thermal response, which imitates the function of thermal demand meters.

The demand calculation updates at the end of each interval. You can set the demand interval from 1 to 60 minutes (in 1-minute increments).

Thermal demand example

The following illustration shows the thermal demand calculation. In this example, the interval is set to 15 minutes. The interval is a window of time that moves across the timeline. The calculation updates at the end of each interval.

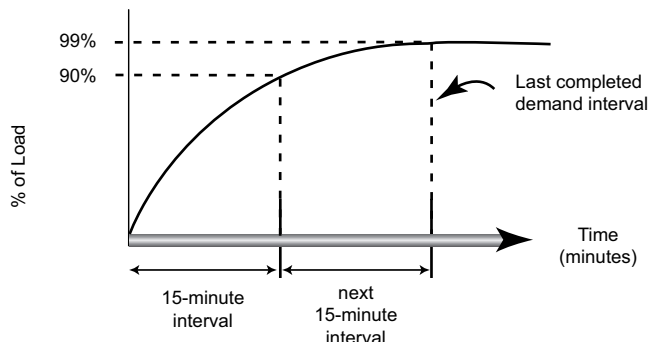

Current demand

The meter calculates current demand using the block interval, synchronized or thermal demand methods.

You can set the demand interval from 1 to 60 minutes in 1 minute increments (for example, 15 minutes).

Predicted demand

The meter calculates predicted demand for the end of the present interval for kW, kVAR, and kVA demand, taking into account the energy consumption so far within the present (partial) interval and the present rate of consumption.

Predicted demand is updated according to the update rate of your meter.

The following illustration shows how a change in load can affect predicted demand for the interval. In this example, the interval is set to 15 minutes.

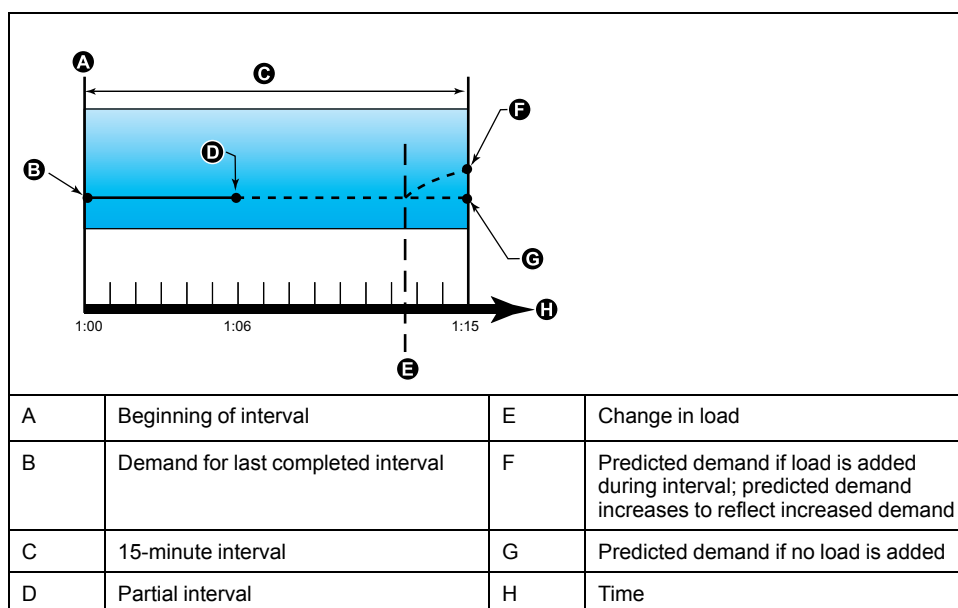

Peak demand

The meter records the peak (or maximum) values for kWD, kVARD, and kVAD power (or peak demand).

The peak for each value is the highest average reading since the meter was last reset. These values are maintained in the meter's non-volatile memory.

The meter also stores the date and time when the peak demand occurred.

Timer

The meter supports an active load timer, meter operation timer, and run time.

Active load timer

Active load timer shows how much time a load has been running, based on the specified minimum current for the load timer setpoint setting.

Meter operation timer

Meter operating timer shows how long the meter has been powered up.

Run time

Run time shows how much time a load has been running, based on accumulated energy - received and delivered.

The run time can be read through communication only.

Multi-tariff

NOTE: Applicable only for PM2230 meter model

The multi-tariff feature allows you to set up different tariffs for storing energy values.

The energy values for different tariffs are stored in registers that correspond to each of those tariffs.

Multi-tariff example

The multi-tariff feature can be used when a utility has set up tariff schedules with different rates based on what day or time of day energy is consumed.

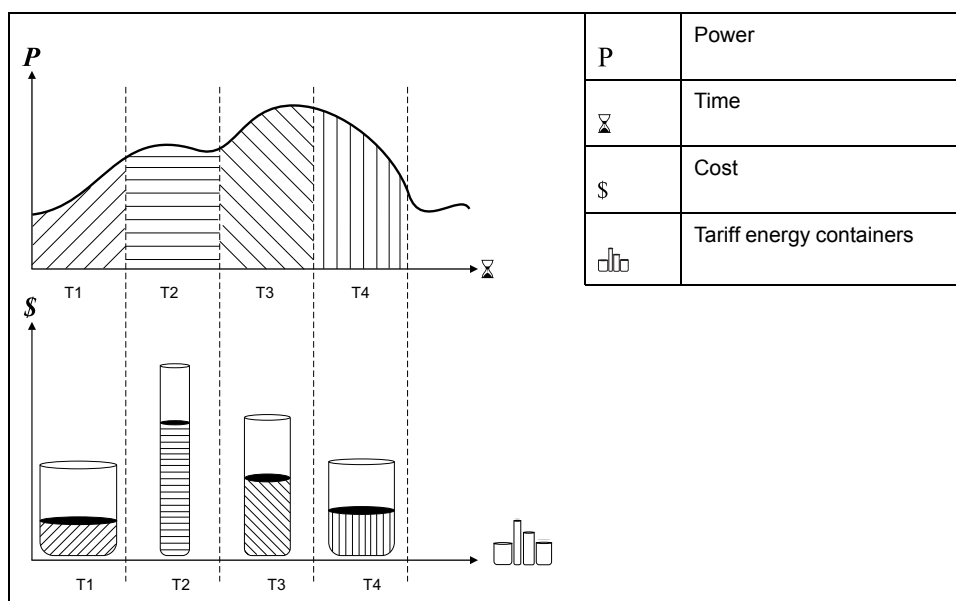

In the above illustration, the area under the power curve equals the energy consumed.

Typically, the utility sets tariff schedules so the cost of energy is higher during high demand or high energy consumption times. How these “tariff energy containers” are configured determines how fast these containers fill, which correlates to increasing energy costs. The price per kWh is lowest at tariff T1 and highest at tariff T2.

Multi-tariff implementation

The meter supports configuration of up to 4 different tariffs to measure and monitor energy usage that can be used in billing or cost applications.

There are three different tariff modes you can use to activate the multi-tariff registers:

- Command mode
- Time of Day mode
- Input mode

Command mode overview

You can use command mode to send a Modbus command to the device which sets the active tariff.

The active tariff is applied to the measured energy until you send another Modbus command that sets a different tariff.

Search for your meter's Modbus register list at www.se.com to download the Modbus map.

Time of day mode overview

You can use time of day mode to create a tariff schedule that specifies where the meter stores energy or input metered data, based on the time of year (month, day), the type of day (every day, weekend, weekday or a specific day of the week), or time of day.

The data collected from the different tariffs can then be used in energy audits or similar costing and budget planning purposes.

Time of day mode tariff validity

A valid time of day tariff has certain conditions and limitations:

- Each tariff must cover a unique time period (tariffs cannot overlap), but there can be periods with no tariff.
- Any number of tariffs, from none to the maximum number of tariffs, can be applied.
- Time of day tariffs do not adjust for daylight savings time.
- Time of day tariffs include February 29th in leap years (however, it is not recommended to have February 29th as a start or end date, as that tariff would be invalid for non-leap years).
- Except for leap years, tariff dates are not year-specific; if you wanted to create a tariff that starts on the first Monday in August, you need to enter the date for that year, then manually update the tariff information for the subsequent years.

Your device performs validation checks as you enter tariff information; it prompts you to change the information that you have entered or set the tariff to disabled if the tariff configuration is invalid. These checks can include:

- Start and end times must be different (for example, you cannot create a tariff that starts at 02:00 and also ends at 02:00).
- Start time can only be earlier than end time for tariffs that are applied every day. You can create a daily tariff that starts at 06:00 and ends at 02:00, but these times are only valid for the Everyday tariff and invalid for the other tariff types.
- Start day must be earlier than end day if the days are in the same month. You cannot create a tariff that starts June 15 and ends June 12.

Time of day tariff creation methods

You can create time of day tariffs using one of the two methods, or a combination of these methods:

- Time of year tariffs divide the year into multiple sections (usually seasons), where each section has one or more day types. For example, a four tariff configuration using this method could have Summer and Winter seasons that also use different weekend and weekday tariffs.
- Daily tariffs can divide days by day of the week, a weekday, a weekend, or every day, and can specify the time of day. For example, a four tariff configuration could have every day in the year divided into six-hour tariff periods or could have two tariffs for weekends and two tariffs for weekdays.

You can combine these methods if, for example you wanted to create a tariff that applies on Mondays from January 1 to June 30, from 09:00 to 17:00. However, since only one tariff can be applied at any time, you cannot use an everyday or

weekday tariff type because you already specified a tariff for the time periods 09:00 to 17:00.

Depending on how you configure the tariffs and the maximum number of tariffs supported by your meter, you may not be able to assign tariffs for the entire year, potentially leaving time gaps that do not have any tariff assigned to them.

Example tariff configurations for a four-tariff system

In these examples, four tariffs are used to cover the entire year (there are no time periods that do not have an associated tariff).

Configuration 1: four tariffs with weekdays and weekends

| Tariff | Type | Start date | End date | Start time | End time |
|--------|---------|-------------|-------------|------------|----------|
| 1 | Weekend | June 21 | December 20 | 00:00 | 23:59 |
| 2 | Weekend | December 21 | June 20 | 00:00 | 23:59 |
| 3 | Weekday | June 21 | December 20 | 00:00 | 23:59 |
| 4 | Weekday | December 21 | June 20 | 00:00 | 23:59 |

NOTE: The end time of 23:59 is actually 23:59:59, or just before midnight.

All weekend days fall into one of two different tariffs, depending on the date. All weekdays fall into one of two different tariffs, depending on the date. This configuration does not use tariffs based on the time of day, or any day types other than weekend or weekday.

Example dates and corresponding tariffs:

- Friday, June 29 = tariff 3
- Sunday, November 28th = tariff 1

Configuration 2: one season for weekends, with off-peak and shoulder hours, two seasons for weekdays, with shoulder hours

| Tariff | Type | Start date | End date | Start time | End time |
|--------|-----------|------------|--------------|------------|----------|
| 1 | Every day | January 1 | December 31 | 23:00 | 04:59 |
| 2 | Weekdays | May 1 | September 20 | 00:00 | 22:59 |
| 3 | Weekdays | October 1 | April 30 | 05:00 | 22:59 |
| 4 | Weekends | January 1 | December 31 | 05:00 | 22:59 |

All days have a tariff applied between 23:00 and 04:59, corresponding to off-peak hours. All weekend days have a tariff applied from 05:00 to 22:59, corresponding to shoulder hours. All weekdays fall into one of two seasons (summer or winter), and have two tariffs applied throughout the day.

Example dates and corresponding tariffs:

- Wednesday, March 21, 08:00 = tariff 3
- Tuesday, January 10, 21:00 = tariff 3
- Sunday, June 24, 14:00 = tariff 4
- Friday, August 17, 00:00 = tariff 1

Input mode overview

You can use input mode to have the digital inputs of the device set to know which tariff is applied to the energy that is presently being consumed.

The number of different tariffs that can be applied is determined by the number of available digital inputs and the total number of tariffs supported by your device.

Digital input assignment for input control mode

You need to assign one or more digital inputs with non-exclusive associations to define the active tariff.

If a digital input is used for multi-tariff, it cannot be used for an exclusive association (such as Demand Sync), but digital inputs can be shared with a non-exclusive association (such as Alarms). To make a digital input available for setting tariffs, any conflicting associations must be manually removed at the source of the original association.

The digital inputs are used as binary counters to identify the appropriate tariff, where off = 0 and on = 1, and most significant bit (MSB) is digital input 2 and least significant bit (LSB) is digital input 1. By this definition, digital input 1 must be associated with the multi-tariff feature in order to set the tariff to **Input** mode.

Digital input requirements for required number of tariffs

| Number of tariffs required | Digital inputs required | |
|----------------------------|---------------------------|---------------------------|
| | Configuration 1 | Configuration 2 |
| 1 | 1 (digital input 1) | 1 (digital input 1) |
| 2 | 1 (digital input 1) | 2 (digital input 1 and 2) |
| 3 | 2 (digital input 1 and 2) | 2 (digital input 1 and 2) |
| 4 | 2 (digital input 1 and 2) | 2 (digital input 1 and 2) |

Configuration 1: 2 tariff assignment using 2 digital inputs

NOTE: There is no inactive tariff with this configuration.

| Tariff | Digital input 2 | Digital input 1 |
|--------|-----------------|-----------------|
| T1 | 0 | 0 |
| T2 | 0 | 1 |

Configuration 2: 2 tariff assignment using 2 digital inputs

NOTE: Digital input configuration 00 means that there are no active tariffs (all tariffs are disabled).

| Tariff | Digital input 2 | Digital input 1 |
|--------|-----------------|-----------------|
| None | 0 | 0 |
| T1 | 0 | 1 |
| T2 | 1 | 0 |

Active tariff control mode

The active tariff is controlled based on the tariff mode.

- When the meter is set to command mode, the active tariff is controlled by the Modbus commands from your energy management system or other Modbus master.
- When the meter is set to input mode, the active tariff is controlled by the status of the digital inputs.
- When the meter is set to time of day mode, the active tariff is controlled by the day type, the start and end times, and the start and end dates.

Configuring time of day mode tariffs using the display

When the meter is set to time of day for tariffs, the active tariff is determined by the day type, the start and end times, and the start and end dates.

The time of day tariff is not a calendar; the meter does not calculate the corresponding day of the week to a specific date, but February 29th is considered a valid date if you are programming the meter during a leap year.

When you enter tariff times using the front panel, be aware that the displayed minute value includes the entire minute. For example, an end time of 01:15 includes the time from 01:15:00 through 01:15:59. To create a tariff period that starts right after this, you must set the next tariff start time to 01:16. Although it may appear that there is a gap between these tariffs, there is not.

1. Navigate to **Maint > Setup**.
2. Enter the setup password (default is "0"), then press **OK**.
3. Navigate to **Meter > Tariff**.
4. Select **Mode** and press **Edit**.
5. Press **+** or **-** to change the setting to **Time of Day**, then press **OK**.
6. Move the cursor to point to the tariff (Tariff 1 to Tariff 4) you want to modify, then press **Edit**.

| Parameter | Values | Description |
|-------------|--|---|
| Day Type | Everyday, Weekday, Weekend, Monday, Tuesday, Wednesday, Thursday, Friday, Saturday or Sunday | Select which day the tariff is active. Only tariffs that are Everyday can have a tariff that includes midnight (for instance, from 11pm to 2am). |
| Start Time | 0000 to 2359 | Set the time when the tariff period starts, using the 24 hour clock format (00:00 to 23:59). The Start Time cannot equal the End Time. |
| End Time | 0000 to 2359 | Set the time when the tariff period ends, using the 24 hour clock format (00:00 to 23:59). The End Time cannot equal the Start Time. |
| Start Month | 1 to 12 | Set the month that the tariff period starts, where 1 = January, 2 = February, 3 = March, 4 = April, 5 = May, 6 = June, 7 = July, 8 = August, 9 = September, 10 = October, 11 = November, 12 = December. |
| Start Day | 1 to 31 | Set the day of the Start Month that the tariff period starts. The Start Day must be earlier than End Day if Start Month equals End Month. |
| End Month | 1 to 12 | The month that the tariff period ends, where 1 = January, 2 = February, 3 = March, 4 = April, 5 = May, 6 = June, 7 = July, 8 = August, 9 = September, 10 = October, 11 = November, 12 = December. |
| End Day | 1 to 31 | The day of the End Month that the tariff period ends. |

7. Modify each parameter as required, then press **OK** to set.
Press the Up and Down arrow buttons to move between parameters.

8. Press the Up arrow to exit, then **Yes** to save your changes.

Repeat for the other tariffs as required.

The meter checks the configuration and display a message if any tariffs have conflicting settings (overlapping tariff periods for example).

Configuring input mode tariffs using the display

Use the display to configure input mode tariffs. You can also configure input mode tariffs using ION Setup.

You cannot configure any digital input tariff if digital input 1 is not available for association. Likewise, digital input 2 must be available to select more than two tariffs.

The status of the digital inputs is used to calculate the binary value of the active tariff, where off = 0 and on = 1. The calculation of the number of tariffs value can differ, depending on the number of digital inputs that can be selected (i.e., inputs that can be associated with multi-tariff).

1. Navigate to **Maint > Setup**.
2. Enter the setup password (default is "0"), then press **OK**.
3. Navigate to **Meter > Tariff**.
4. Select **Mode** and press **Edit**.
5. Press **+** or **-** to change the setting to **Input**, then press **OK**.

NOTE: If a digital input association error prompt displays, you must exit from the tariff setup screens and remove the digital input association.

6. Navigate to **Tariffs**, then press **Edit**.
7. Press **+** or **-** to change the number of tariffs you want to set up and press **OK**.
The maximum number of tariffs that you can apply is determined by the number of available digital inputs.
8. Navigate to **Inputs**, then press **Edit**.
If applicable, press **+** or **-** to change how many digital inputs you want to use to control which tariff is selected (active). Press **OK**.
9. Press the up arrow to exit, then **Yes** to save your changes.

Power quality

Harmonics overview

This section describes the meter's power quality features and how to access power quality data. The meter measures voltage and current harmonics up to the 15th harmonic and 31st harmonic, and calculates Total Harmonic Distortion (THD %).

Harmonics are integer multiples of the fundamental frequency of the power system. Harmonics information is required for compliance to system power quality standards such as EN50160 and meter power quality standards such as IEC 61000-4-30.

The meter measures fundamental and higher harmonics relative to the fundamental frequency. The meter's power system setting defines which phases are present and determines how line-to-line or line-to-neutral voltage harmonics and current harmonics are calculated.

Harmonics are used to identify whether the supplied system power meets required power quality standards, or if non-linear loads are affecting your power system. Power system harmonics can cause current flow on the neutral conductor, and damage to equipment such as increased heating in electric motors. Power conditioners or harmonic filters can be used to minimize unwanted harmonics.

Total harmonic distortion %

Total harmonic distortion (THD%) is a measure of the total per-phase voltage or current harmonic distortion present in the power system.

THD% provides a general indication of the quality of a waveform. THD% is calculated for each phase of both voltage and current.

Harmonic content calculations

Harmonic content (H_C) is equal to the RMS value of all the non-fundamental harmonic components in one phase of the power system.

The meter uses the following equation to calculate H_C :

$$H_C = \sqrt{(H_2)^2 + (H_3)^2 + (H_4)^2 \dots}$$

THD% calculations

THD% is a quick measure of the total distortion present in a waveform and is the ratio of harmonic content (H_C) to the fundamental harmonic (H_1).

By default, the meter uses the following equation to calculate THD%:

$$THD = \frac{H_C}{H_1} \times 100\%$$

Displaying harmonics data

The meter displays voltage and current THD% data on the front panel, while the phase wise THD% data can be read through communication.

1. Navigate to **THD**.
2. Press **Amps**, **V L-L**, or **V L-N** to view current or voltage THD%.

3. Press Up arrow to exit the page.

Maintenance and upgrades

Maintenance overview

The meter does not contain any user-serviceable parts. If the meter requires service, contact your local Schneider Electric Technical Support representative.

| |
|--|
| <i>NOTICE</i> |
| <p>METER DAMAGE</p> <ul style="list-style-type: none"> • Do not open the meter case. • Do not attempt to repair any components of the meter. <p>Failure to follow these instructions can result in equipment damage.</p> |

Do not open the meter. Opening the meter voids the warranty.

Troubleshooting LED indicators

Abnormal heartbeat / serial communications LED behavior could mean potential problems with the meter.

| Problem | Probable causes | Possible solutions |
|---|--|---|
| LED flash rate does not change when data is sent from the host computer. | Communications wiring | If using a serial-to-RS-485 converter, trace and check that all wiring from the computer to the meter is properly terminated. |
| | Internal hardware problem | Perform a hard reset: turn off control power to the meter, then re-apply power. If the problem persists, contact Technical Support. |
| Heartbeat / serial communications LED remains lit and does not flash ON and OFF | Internal hardware problem | Perform a hard reset: turn off control power to the meter, then re-apply power. If the problem persists, contact Technical Support. |
| Heartbeat / serial communications LED flashes, but the display is blank. | Display setup parameters incorrectly set | Review display parameter setup. |

If the problem is not fixed after troubleshooting, contact Technical Support for help and ensure you have your meter’s firmware version, model and serial number information available.

Meter memory

The meter stores configuration and logging information in non-volatile memory and a long-life memory chip.

The meter uses its non-volatile memory (NVRAM) to retain all data and metering configuration values.

Meter battery

The internal battery in the meter keeps the meter’s clock running when it is powered down to help maintain the meter time.

The life expectancy of the meter's internal battery is estimated to be over 10 years at 25 °C under typical operating conditions.

Viewing firmware version, model and serial number

You can view the meter's firmware version, model and serial number from the display panel.

1. Navigate to **Maint > Diag**.
2. Press **Info** to view meter model, serial number, date of manufacturing, OS version, and RS version.
3. Press **St Edt** to view **Number of Edits**, **Date of Last Edit** and **Time of Last Edit**.
4. Press Up to exit.

Firmware upgrades

There are a number of reasons why you may want to upgrade your meter's firmware.

- Improve meter performance (e.g., optimize processing speed)
- Enhance existing meter features and functions
- Add new functionality to the meter
- Achieve compliance to new industry standards

Technical assistance

Visit www.se.com for support and assistance with lost passwords or other technical problems with the meter.

Make sure you include your meter's model, serial number and firmware version in your email or have it readily available if calling Technical Support.

Verifying accuracy

Overview of meter accuracy

All meters are tested and verified at the factory in accordance with International Electrotechnical Commission (IEC) and Institute of Electrical and Electronics Engineers (IEEE) standards.

Your meter typically does not require re-calibration. However, in some installations a final accuracy verification of the meters is required, especially if the meters will be used for revenue or billing applications.

Accuracy test requirements

The most common method for testing meter accuracy is to apply test voltages and currents from a stable power source and compare the meter's readings with readings from a reference device or energy standard.

Signal and power source

The meter maintains its accuracy during voltage and current signal source variations but its energy pulsing output needs a stable test signal to help produce accurate test pulses. The meter's energy pulsing mechanism needs approximately 10 seconds to stabilize after every source adjustment.

The meter must be connected to control power in order to conduct accuracy verification testing. Refer to your meter's installation documentation for power supply specifications.

⚠️ DANGER

HAZARD OF ELECTRIC SHOCK, EXPLOSION, OR ARC FLASH

Verify the device's power source meets the specifications for your device's power supply.

Failure to follow these instructions will result in death or serious injury.

Control equipment

Control equipment is required for counting and timing the pulse outputs from an energy pulsing LED.

- Most standard test benches have an arm equipped with optical sensors to detect LED pulses (the photodiode circuitry converts detected light into a voltage signal).
- The reference device or energy standard typically has digital inputs that can detect and count pulses coming from an external source (i.e., the meter's pulse output).

NOTE: The optical sensors on the test bench can be disrupted by strong sources of ambient light (such as camera flashes, florescent tubes, sunlight reflections, floodlights, etc.). This can cause test errors. Use a hood, if necessary, to block out ambient light.

Environment

The meter should be tested at the same temperature as the testing equipment. The ideal temperature is about 23 °C (73 °F). Make sure the meter is warmed up sufficiently before testing.

A warm-up time of 30 minutes is recommended before beginning energy accuracy verification testing. At the factory, the meters are warmed up to their typical operating temperature before calibration to help ensure that the meters will reach their optimal accuracy at operating temperature.

Most high precision electronic equipment requires a warm up time before it reaches its specified performance levels. Energy meter standards allow the manufacturers to specify meter accuracy derating due to ambient temperature changes and self-heating.

Your meter complies with and meets the requirements of these energy metering standards.

For a list of accuracy standards that your meter complies to, contact your local Schneider Electric representative or download the meter brochure from www.se.com.

Reference device or energy standard

To help ensure the accuracy of the test, it is recommended that you use a reference device or reference energy standard with a specified accuracy that is 6 to 10 times more accurate than the meter under test. Before you start testing, the reference device or energy standard should be warmed up as recommended by its manufacturer.

NOTE: Verify the accuracy and precision of all measurement equipment used in accuracy testing (for example, voltmeters, ammeters, power factor meters).

Verifying accuracy test

The following tests are guidelines for accuracy testing your meter; your meter shop may have specific testing methods.

DANGER

HAZARD OF ELECTRIC SHOCK, EXPLOSION, OR ARC FLASH

- Apply appropriate personal protective equipment (PPE) and follow safe electrical work practices. See NFPA 70E in the USA, CSA Z462 or applicable local standards.
- Turn off all power supplying this device and the equipment in which it is installed before working on the device or equipment.
- Always use a properly rated voltage sensing device to confirm that all power is off.
- Do not exceed the device's ratings for maximum limits.
- Verify the device's power source meets the specifications for your device's power supply.

Failure to follow these instructions will result in death or serious injury.

1. Turn off all power supplying this device and the equipment in which it is installed before working on the device or equipment.
2. Use a properly rated voltage sensing device to confirm that all power is off.

3. Connect the test voltage and current source to the reference device or energy standard. Ensure all voltage inputs to the meter under test are connected in parallel and all current inputs are connected in series.

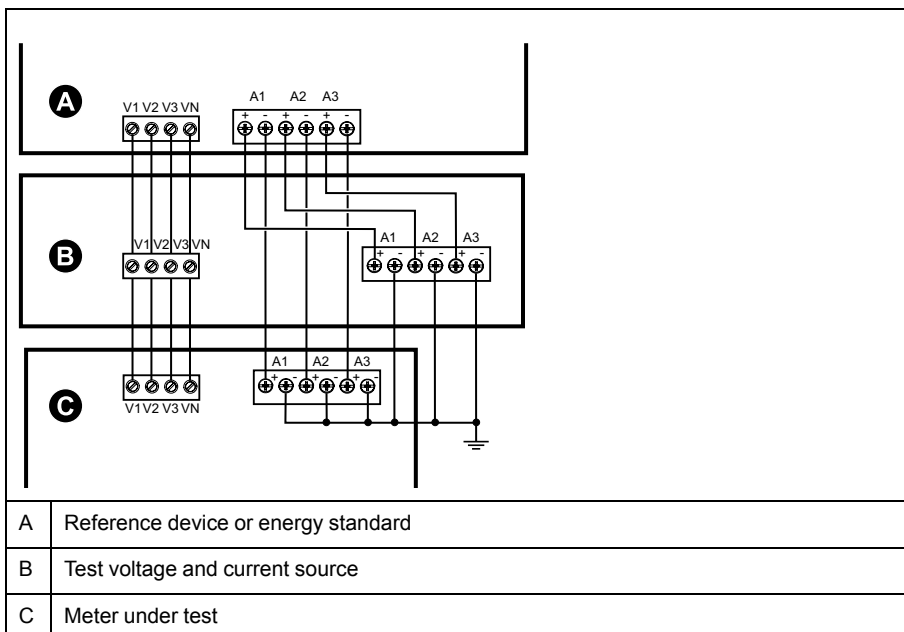

4. Connect the control equipment used for counting the standard output pulses using one of these methods:

| Option | Description |
|--------------------|---|
| Energy pulsing LED | Align the red light sensor on the standard test bench armature over the energy pulsing LED. |
| Pulse output | Connect the meter's pulse output to the standard test bench pulse counting connections. |

NOTE: When selecting which method to use, be aware that energy pulsing LEDs and pulse outputs have different pulse rate limits.

5. Before performing the verification test, let the test equipment power up the meter and apply voltage for at least 30 seconds. This helps stabilize the internal circuitry of the meter.
6. Configure the meter's parameters for verifying accuracy testing.
7. Depending on the method selected for counting the energy pulses, configure the meter's energy pulsing LED or one of the pulse outputs to perform energy pulsing. Set the meter's energy pulse constant so it is in sync with the reference test equipment.
8. Perform accuracy verification on the test points. Run each test point for at least 30 seconds to allow the test bench equipment to read an adequate number of pulses. Allow 10 seconds of dwell time between test points.

Required pulses calculation for accuracy verification testing

Accuracy verification test equipment typically requires you to specify the number of pulses for a specific test duration.

The reference test equipment typically requires you to specify the number of pulses required for a test duration of "t" seconds. Normally, the number of pulses required is at least 25 pulses, and the test duration is greater than 30 seconds.

Use the following formula to calculate the required number of pulses:

$$\text{Number of pulses} = P_{\text{tot}} \times K \times t/3600$$

Where:

- P_{tot} = total instantaneous power in kilowatts (kW)
- K = the meter's pulse constant setting, in pulses per kWh
- t = test duration, in seconds (typically greater than 30 seconds)

Total power calculation for accuracy verification testing

Accuracy verification testing supplies the same test signal (total power) to both the energy reference/standard and the meter under test.

Total power is calculated as follows, where:

- P_{tot} = total instantaneous power in kilowatts (kW)
- V_{LN} = test point line-to-neutral voltage in volts (V)
- I = test point current in amps (A)
- PF = power factor

The result of the calculation is rounded up to the nearest integer.

For a balanced 3-phase Wye system:

$$P_{tot} = 3 \times V_{LN} \times I \times PF \times 1 \text{ kW}/1000 \text{ W}$$

NOTE: A balanced 3-phase system assumes that the voltage, current and power factor values are the same for all phases.

For a single-phase system:

$$P_{tot} = V_{LN} \times I \times PF \times 1 \text{ kW}/1000 \text{ W}$$

Percentage error calculation for accuracy verification testing

Accuracy verification testing requires you to calculate the percentage error between the meter being tested and the reference/standard.

Calculate the percentage error for every test point using the following formula:

$$\text{Energy error} = (EM - ES) / ES \times 100\%$$

Where:

- EM = energy measured by the meter under test
- ES = energy measured by the reference device or energy standard.

NOTE: If accuracy verification reveals inaccuracies in your meter, they may be caused by typical sources of test errors. If there are no sources of test errors present, please contact your local Schneider Electric representative.

Accuracy verification test points

The meter should be tested at full and light loads and at lagging (inductive) power factors to help ensure testing over the entire range of the meter.

The test amperage and voltage input rating are labeled on the meter. Refer to the installation sheet or data sheet for your meter's nominal current, voltage and frequency specifications.

| Watt-hour test point | Sample accuracy verification test point |
|---------------------------------------|---|
| Full load | 100% to 200% of the nominal current, 100% of the nominal voltage and nominal frequency at unity power factor or one (1). |
| Light load | 10% of the nominal current, 100% of the nominal voltage and nominal frequency at unity power factor or one (1). |
| Inductive load (lagging power factor) | 100% of the nominal current, 100% of the nominal voltage and nominal frequency at 0.50 lagging power factor (current lagging voltage by 60° phase angle). |

| VAR-hour test point | Sample accuracy verification test point |
|---------------------------------------|---|
| Full load | 100% to 200% of the nominal current, 100% of the nominal voltage and nominal frequency at zero power factor (current lagging voltage by 90° phase angle). |
| Light load | 10% of the nominal current, 100% of the nominal voltage and nominal frequency at zero power factor (current lagging voltage by 90° phase angle). |
| Inductive load (lagging power factor) | 100% of the nominal current, 100% of the nominal voltage and nominal frequency at 0.87 lagging power factor (current lagging voltage by 30° phase angle). |

Energy pulsing considerations

The meter’s energy pulsing LED and pulse outputs are capable of energy pulsing within specific limits.

| Description | Energy pulsing LED | Pulse output |
|-------------------------|--------------------------|--------------|
| Maximum pulse frequency | 35 Hz | 20 Hz |
| Minimum pulse constant | 1 pulse per k_h | |
| Maximum pulse constant | 9,999,000 pulses per k_h | |

The pulse rate depends on the voltage, current and PF of the input signal source, the number of phases, and the VT and CT ratios.

If Ptot is the instantaneous power (in kW) and K is the pulse constant (in pulses per kWh), then the pulse period is:

$$\text{Pulse period (in seconds)} = \frac{3600}{K \times P_{tot}} = \frac{1}{\text{Pulse frequency (Hz)}}$$

VT and CT considerations

Total power (Ptot) is derived from the values of the voltage and current inputs at the secondary side, and takes into account the VT and CT ratios.

The test points are always taken at the secondary side, regardless of whether VTs or CTs are used.

If VTs and CTs are used, you must include their primary and secondary ratings in the equation. For example, in a balanced 3-phase Wye system with VTs and CTs:

$$P_{tot} = 3 \times V_{LN} \times \frac{V_{T_p}}{V_{T_s}} \times I \times \frac{CT_p}{CT_s} \times PF \times \frac{1 \text{ kW}}{1000 \text{ W}}$$

where Ptot = total power, VT_p = VT primary, VT_s = VT secondary, CT_p = CT primary, CT_s = CT secondary and PF = power factor.

Example calculations

This example calculation shows how to calculate power, pulse constants and maximum pulse frequency, and how to determine a pulse constant that reduces the maximum pulse frequency.

A balanced 3-phase Wye system uses 480:120 volt VTs and 120:5 amp CTs. The signals at the secondary side are 119 volts line-to-neutral and 5.31 amps, with a power factor of 0.85. The desired pulse output frequency is 20 Hz (20 pulses per second).

1. Calculate the typical total output power (P_{tot}):

$$P_{tot} = 3 \times 119 \times \frac{480}{120} \times 5.31 \times \frac{120}{5} \times 0.85 \times \frac{1 \text{ kW}}{1000 \text{ W}} = 154.71 \text{ kW}$$

2. Calculate the pulse constant (K):

$$K = \frac{3600 \times (\text{pulse frequency})}{P_{tot}} = \frac{3600 \text{ seconds/hour} \times 20 \text{ pulses/second}}{154.71 \text{ kW}}$$

$$K = 465.5 \text{ pulses / kWh}$$

3. At full load (120% of nominal current = 6 A) and power factor (PF = 1), calculate the maximum total output power (P_{max}):

$$P_{max} = 3 \times 119 \times \frac{480}{120} \times 6 \times \frac{100}{5} \times 1 \times \frac{1 \text{ kW}}{1000 \text{ W}} = 205.6 \text{ kW}$$

4. Calculate the maximum output pulse frequency at P_{max}:

$$\text{Maximum pulse frequency} = \frac{K \times P_{max}}{3600} = \frac{465.5 \text{ pulses / kWh} \times 205.6 \text{ kW}}{3600 \text{ seconds/hour}}$$

$$\text{Maximum pulse frequency} = 26.6 \text{ pulses/second} = 26.6 \text{ Hz}$$

5. Check the maximum pulse frequency against the limits for the LED and pulse outputs:

- 26.6 Hz ≤ LED maximum pulse frequency (35 Hz)
- 26.6 Hz > pulse output maximum pulse frequency (20 Hz)

NOTE: The maximum pulse frequency is within the limits for LED energy pulsing. However, the maximum pulse frequency is greater than the limits for pulse output energy pulsing. Pulse output frequencies greater than 20 Hz will saturate the pulse output and cause it to stop pulsing. Therefore in this example, you can only use the LED for energy pulsing.

Adjustments to allow energy pulsing at the pulse outputs

If you want to use the pulse output, you must reduce the output pulse frequency so it is within the limits.

Using the values from the above example, the maximum pulse constant for the pulse output is:

$$K_{max} = \frac{3600 \times (\text{pulse output maximum pulse frequency})}{P_{max}} = \frac{3600 \times 20}{205.6}$$

$$K_{max} = 350.14 \text{ pulses per kWh}$$

1. Set the pulse constant (K) to a value below K_{max}, for example, 300 pulses/kWh. Calculate the new maximum output pulse frequency at P_{max}:

$$\text{New maximum pulse frequency} = \frac{K \times P_{max}}{3600} = \frac{300 \text{ pulses/kWh} \times 205.6 \text{ kW}}{3600 \text{ seconds/hour}}$$

$$\text{New maximum pulse frequency} = 17.1 \text{ pulses/second} = 17.1 \text{ Hz}$$

2. Check the new maximum pulse frequency against the limits for the LED and pulse outputs:
 - $17.1 \text{ Hz} \leq \text{LED maximum pulse frequency (35 Hz)}$
 - $17.1 \text{ Hz} \leq \text{pulse output maximum frequency (20 Hz)}$As expected, changing K to a value below Kmax allows you to use the pulse output for energy pulsing.
3. Set the new pulse constant (K) on your meter.

Typical sources of test errors

If you see excessive errors during accuracy testing, examine your test setup and test procedures to eliminate typical sources of measurement errors.

Typical sources of accuracy verification testing errors include:

- Loose connections of voltage or current circuits, often caused by worn-out contacts or terminals. Inspect terminals of test equipment, cables, test harness and the meter under test.
- Meter ambient temperature is significantly different than 23 °C (73 °F).
- Floating (ungrounded) neutral voltage terminal in any configuration with unbalanced phase voltages.
- Inadequate meter control power, resulting in the meter resetting during the test procedure.
- Ambient light interference or sensitivity issues with the optical sensor.
- Unstable power source causing energy pulsing fluctuations.
- Incorrect test setup: not all phases connected to the reference device or the energy standard. All phases connected to the meter under test should also be connected to the reference meter/standard.
- Moisture (condensing humidity), debris or pollution present in the meter under test.

Power and power factor

Power and power factor

The sampled measurements taken at the meter's voltage and current inputs provide data for calculating power and power factor.

In a balanced 3-phase alternating current (AC) power system source, the AC voltage waveforms on the current-carrying conductors are equal but offset by one-third of a period (a phase angle shift of 120 degrees between the three voltage waveforms).

Current phase shift from voltage

Electrical current can lag, lead, or be in phase with the AC voltage waveform, and is typically associated with the type of load — inductive, capacitive or resistive.

For purely resistive loads, the current waveform is in phase with the voltage waveform. For capacitive loads, current leads voltage. For inductive loads, current lags voltage.

The following diagrams show how voltage and current waveforms shift based on load type under ideal (laboratory) conditions.

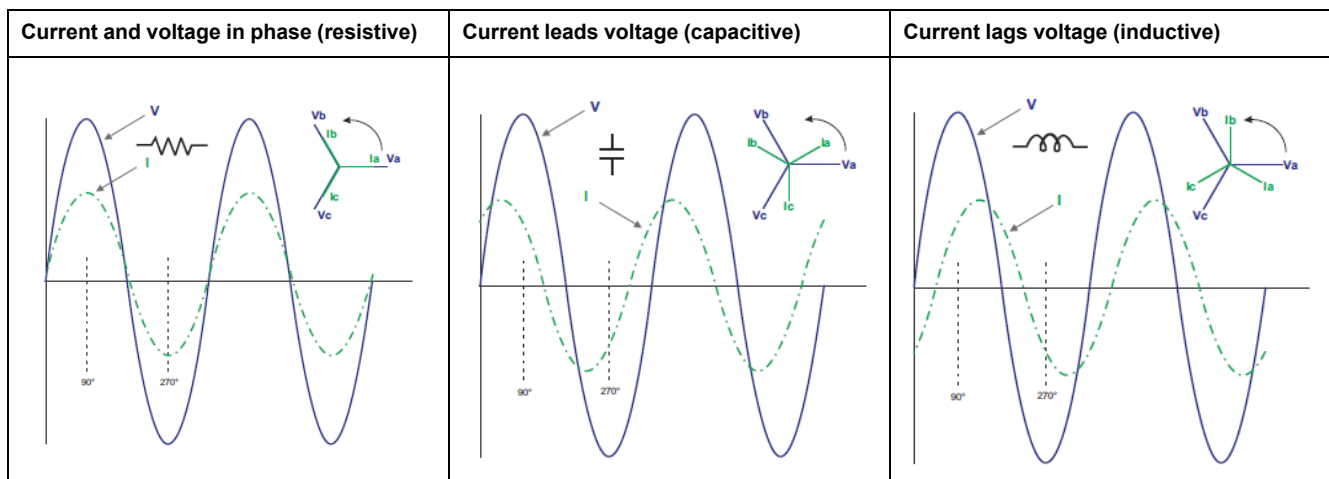

Real, reactive and apparent power (PQS)

A typical AC electrical system load has both resistive and reactive (inductive or capacitive) components.

Real power, also known as active power (P) is consumed by resistive loads. Reactive power (Q) is either consumed by inductive loads or generated by capacitive loads.

Apparent power (S) is the capacity of your measured power system to provide real and reactive power.

The units for power are watts (W or kW) for real power P, vars (VAR or kVAR) for reactive power Q, and volt-amps (VA or kVA) for apparent power S.

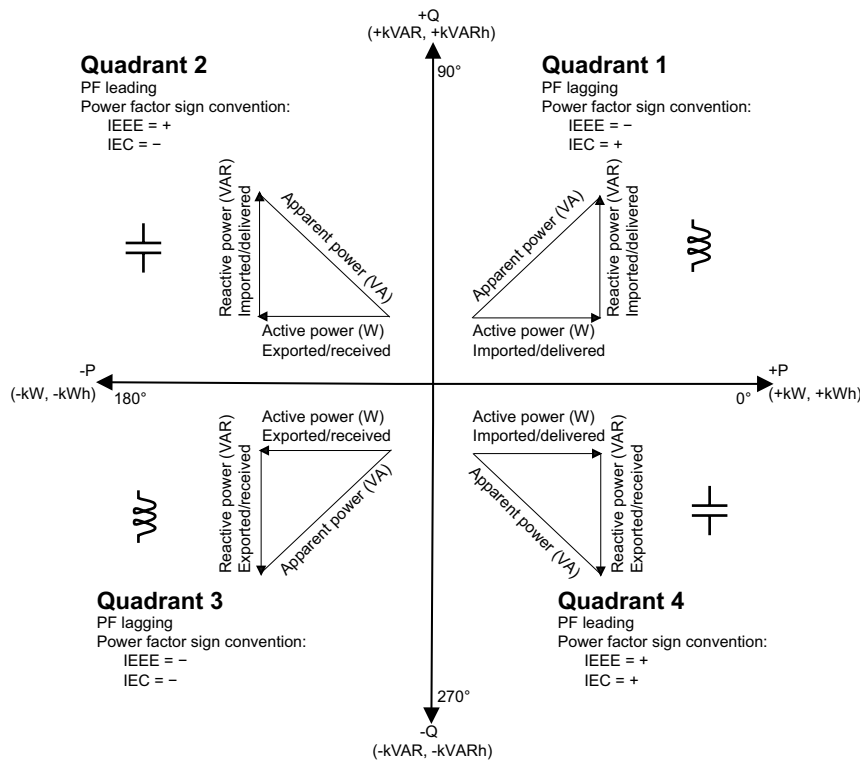

Power flow

Positive real power P(+) flows from the power source to the load. Negative real power P(-) flows from the load to the power source.

Power factor (PF)

Power factor (PF) is the ratio of real power (P) to apparent power (S).

PF is provided as a number between -1 and 1 or as a percentage from -100% to 100%, where the sign is determined by the convention.

$$PF = \frac{P}{S}$$

A purely resistive load has no reactive components, so its power factor is 1 (PF = 1, or unity power factor). Inductive or capacitive loads introduce a reactive power (Q) component to the circuit which causes the PF to become closer to zero.

True PF and displacement PF

The meter supports true power factor and displacement power factor values:

- True power factor includes harmonic content.
- Displacement power factor only considers the fundamental frequency.

NOTE: Unless specified, the power factor displayed by the meter is true power factor.

Power factor sign convention

Power factor sign (PF sign) can be positive or negative, and is defined by the conventions used by the IEEE or IEC standards.

You can set the power factor sign (PF sign) convention that is used on the display to either IEC or IEEE.

PF sign convention: IEC

PF sign correlates with the direction of real power (kW) flow.

- Quadrant 1 and 4: Positive real power (+kW), the PF sign is positive (+).
- Quadrant 2 and 3: Negative real power (-kW), the PF sign is negative (-).

PF sign convention: IEEE

PF sign is correlates with the PF lead/lag convention, in other words, the effective load type (inductive or capacitive):

- For a capacitive load (PF leading, quadrant 2 and 4), the PF sign is positive (+).
- For an inductive load (PF lagging, quadrant 1 and 3), the PF sign is negative (-).

Power factor min/max convention

The meter uses a specific convention for determining the power factor minimum and maximum values.

- For negative PF readings, the minimum PF value is the measurement closest to -0 for PF readings between -0 to -1. For positive PF readings, the minimum PF value is the measurement closest to +1 for PF readings between +1 to +0.
- For negative PF readings, the maximum PF value is the measurement closest to -1 for PF readings between -0 to -1. For positive PF readings, the maximum PF value is the measurement closest to +0 for PF readings between +1 to +0.

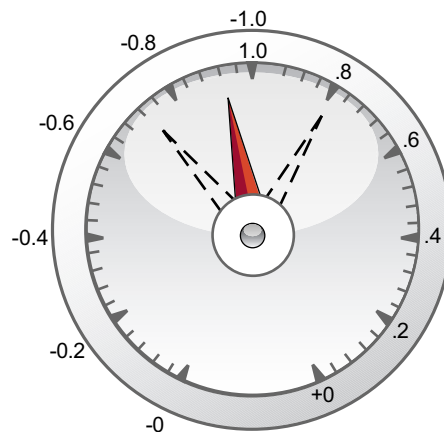

Power factor register format

The meter performs a simple algorithm to the PF value then stores it in the PF register.

Each power factor value (PF value) occupies one floating point register for power factor (PF register). The meter and software interpret the PF register for all reporting or data entry fields according to the following diagram:

Specifications

The specifications contained in this section are subject to change without notice.
For installation and wiring information, refer to the meter installation sheet.

Mechanical characteristics

| | |
|---------------------------------------|---|
| IP degree of protection (IEC 60529-1) | Front display: IP54 Meter body: IP30 |
| Panel thickness maximum | 6.0 mm (0.25 in) maximum |
| Mounting position | Vertical |
| Display type | LCD display: Monochrome graphical LCD |
| Keypad | 4 button with intuitive navigation |
| Front panel LED indicators | Green LED (heartbeat / serial communications activity) Amber LED (alarm / energy pulse output) |
| Weight | ~ 300 gms |
| Dimensions W x H x D | 96 x 96 x 73 mm max |
| Protection features | Password protected for set-up parameters |
| Relay | 2 Form A electro-mechanical relay |

Electrical characteristics

Measurement accuracy

| | |
|-----------------------------------|--|
| Current, Phase | ± 0.5% for Class 1.0 and Class 0.5S |
| Voltage L-N, L-L | ± 0.5% for Class 1.0 and Class 0.5S |
| Power Factor | ± 0.01 count for Class 1.0 and Class 0.5S |
| Power | PM2210, PM2220: <ul style="list-style-type: none"> • Active power: ± 1% for Class 1.0 • Reactive power: ± 1% for Class 1.0 • Apparent power: ± 1% for Class 1.0 PM2230: <ul style="list-style-type: none"> • Active power: ± 0.5% for Class 0.5S • Reactive power: ± 1% for Class 0.5S • Apparent power: ± 0.5% for Class 0.5S |
| Frequency | ± 0.05% for Class 1.0 and Class 0.5S |
| Active Energy | Class 0.5S as per IEC 62053-22 and Class 1.0 as per IEC 62053-21 for both 5 A and 1 A ² nominal CT. |
| Reactive Energy | Class 1.0 as per IEC 62053-24 for 5 A nominal CT |
| THD and Individual Harmonic V & A | ± 5% Full scale for THD & Individual harmonics |

2. For 1 A CT nominal, additional error of ±1% from 50 mA to 150 mA, ±2% for current > 10 mA to < 50 mA. Partial standard compliance for Class 0.5S meter type (energy test clause only).

Voltage inputs

| | |
|----------------------------|---|
| VT primary | 999 kV L-L max, starting voltage depends on VT ratio |
| V nominal | 277 V L-N / 480 V L-L |
| Measured V with full range | 35 - 480 V L-L (20 - 277 V L-N), CAT III 35 - 600 V L-L (20 - 347 V L-N), CAT II |
| Permanent overload | 750 V AC L-L |
| Impedance | ≥ 5 MΩ |
| Frequency | 50 / 60 Hz nominal ± 5% |
| VA burden | < 0.2 VA at 240 V AC L-N |

Current inputs

| | |
|--|---|
| CT ratings | Primary adjustable 1 A to 32767 A Secondary 1 A or 5 A I-nominal |
| Measured current | 5 mA to 6 A |
| Suppression current (to disregard negligible load) | 5 mA to 99 mA |
| Withstand | Continuous 12 A; 50 A at 10 sec/hr, 500 A at 1 sec/hr |
| Impedance | < 0.3 mΩ |
| Frequency | 50 / 60 Hz nominal |
| VA Burden | < 0.024 VA at 6 A |

AC control power - PM2210/PM2220

| | |
|-------------------|---|
| Operating range | 44 - 277 V L-N ± 10% |
| Burden | < 6 VA at 277 V L-N |
| Frequency range | 45 - 65 Hz |
| Ride-through time | 100 ms typical at 120V AC and maximum burden 400 ms typical at 230 V AC and maximum burden |

AC control power - PM2230

| | |
|-------------------|---|
| Operating range | 80 - 277 V L-N ± 10% |
| Burden | < 8 VA at 277 V L-N |
| Frequency range | 45 - 65 Hz |
| Ride-through time | 100 ms typical at 120 V AC and maximum burden - <i>50 ms with analog IO module</i> 400 ms typical at 230 V AC and maximum burden - <i>250 ms with analog IO module</i> |

DC control power - PM2210/PM2220

| | |
|-------------------|--|
| Operating range | 48 - 277 V DC ± 10% |
| Burden | < 2 W at 277 V DC |
| Ride-through time | 50 ms typical at 125 V DC and maximum burden |

DC control power - PM2230

| | |
|-------------------|--|
| Operating range | 100 - 277 V DC ± 10% |
| Burden | < 3.3 W at 277 V DC |
| Ride-through time | 50 ms typical at 125 V DC and maximum burden |

Displays update

| | |
|---------------|------|
| Instantaneous | 1 s |
| Demand | 15 s |
| Harmonics | 5 s |

Wiring configuration

| | |
|-------------------|--|
| User programmable | Configuration through both HMI and ION setup |
| | 1ph 2W, L-N 1ph 2W, L-L 1ph 3W, L-L with N (2 phase) 3ph 3W, Delta, Ungrounded 3ph 4W, Wye Grounded 3ph 3W, Delta, Corner Grounded 3ph 3W, Wye, Ungrounded 3ph 3W, Wye Grounded 3ph 3W, Wye, Resistance Grounded 3ph 4W, Open Delta, Center-Tapped 3ph 4W, Delta, Center-Tapped 3ph 4W, Wye, Ungrounded 3ph 4W, Wye, Resistance Grounded |

Digital I/O - PM2230

| | |
|--|------------------------|
| Isolation | 2.5 kV RMS |
| Digital (Status) Input | |
| Voltage ratings | ON 18 to 36 V DC |
| | OFF 0 to 4 V DC |
| Digital Output | |
| Load voltage | ≤ 40 V DC |
| Load current | ≤ 20 mA |
| On resistance | ≤ 50 Ω |
| Pulse duration for digital output ³ | [20, 25, 50, 100] ms |

Analog I/O - PM2230

| | |
|--------------------------|---------|
| Update rate | 1 s |
| Analog Input | |
| Measurement scale | 4-20 mA |
| Maximum source impedance | > 500 Ω |
| Analog Output | |
| Measurement scale | 4-20 mA |
| Load impedance | ≤ 600 Ω |

Relay - PM2230

| | |
|-----------------|---------------|
| Voltage ratings | 250 V AC / 2A |
| | 24 V DC / 2A |

3. Indicates the feature is configurable through communication.

Relay - PM2230 (Continued)

| | |
|-------------------|---|
| Switching current | 5 A, 250 V AC / 30 V DC (cos φ=1), 100 k cycles 2 A, 250 V AC / 30 V DC (cos φ=0.4), 100 k cycles 500 mA, 250 V AC / 30 V DC , 1 M cycles |
| Output frequency | 0.5 Hz maximum (1 second ON / 1 second OFF) |
| Whetting Voltage | 24 V DC / 8 mA maximum |

Environmental characteristics

| | |
|-----------------------|---|
| Operating temperature | -10 °C to +60 °C (14 °F to 140 °F) |
| Storage temperature | -25 °C to +70 °C (-13 °F to 158 °F) |
| Humidity rating | 5% to 95% RH at 50 °C (122 °F) (non-condensing) |
| Pollution degree | 2 |
| Altitude | < 2000 m (6562 ft) |
| Location | Not suitable for wet locations |
| Product life | > 7 years |

EMC (electromagnetic compatibility)⁺⁵

| | |
|-----------------------------|----------------------------------|
| Electrostatic discharge | IEC 61000-4-2 |
| Immunity to radiated field | IEC 61000-4-3 |
| Immunity to fast transients | IEC 61000-4-4 |
| Immunity to impulse waves | IEC 61000-4-5 |
| Conducted immunity | IEC 61000-4-6 |
| Immunity to magnetic field | IEC 61000-4-8 |
| Immunity to voltage dips | IEC 61000-4-11 |
| Emissions (IEC61326-1) | Emissions FCC Part 15 Class A/CE |

⁺⁵ Tested as per IEC 61326-1 standard for Emission

Safety

| | |
|---|---|
| Europe | CE, as per IEC 61010-1 Ed-3 |
| US and Canada | cULus per UL 61010-1 CAN / CSA-C22.2 No. 61010-1, for 600 V AC |
| Measurement category (Voltage and Current inputs) | CAT III up to 480 V L-L CAT II up to 600 V L-L |
| Overvoltage category (Control power) | CAT III up to 300 V L-N |
| Dielectric | As per IEC / UL 61010-1 Ed-3 |
| Protective Class | II, Double insulated for user accessible parts |
| Other certification | RCM IEC 61557-12 standard for Class 0.5 (PM2230) |

RS-485 communications

| | |
|--|---|
| Number of ports | 1 |
| Maximum cable length | 1000 m (3280 ft) |
| Maximum number of devices (unit loads) | Up to 32 devices on the same bus |
| Parity | Even, Odd, None (1 stop bit for Odd or Even parity; 2 stop bits for None) |
| Baud rate | 4800, 9600, 19200, 38400 |
| Isolation | 2.5 kV RMS, double insulated |

Pulse output

| | |
|--------------------|---|
| Pulse output (POP) | <p>Max 40 V DC, 20 mA</p> <p>20 ms ON time</p> <p>Configurable pulse weight from 1 to 9999000 pulse / k_h (kWh, kVAh, or kVARh)</p> |
|--------------------|---|

Real-time clock

| | |
|---------------------|--|
| Battery backup time | <p>3 years</p> <p>NOTE: When date and time is configured and meter is in off state.</p> |
|---------------------|--|

Schneider Electric
35 rue Joseph Monier
92500 Rueil Malmaison
France

+ 33 (0) 1 41 29 70 00

www.se.com

As standards, specifications, and design change from time to time,
please ask for confirmation of the information given in this publication.

© 2020 – Schneider Electric. All rights reserved.

NHA2778902-05